

***STAR FLEET***  
***STARSHIP RECOGNITION MANUAL***

***VOLUME TWO***  
***SHIPS OF SUPPORT***  
***2268***

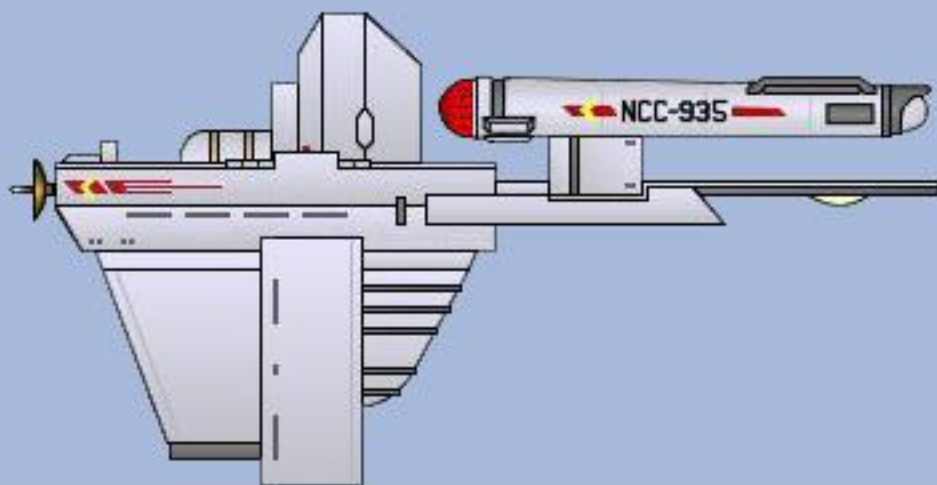

## FOREWORD

AT LAST! THE SECOND VOLUME! IT'S BEEN AN INTERESTING PIECE OF WORKING GETTING THIS SET TOGETHER, SINCE IT FOCUSES ON A LOT OF THE 'LESSER' CRAFT FOUND WITHIN THE *STAR TREK* UNIVERSE. THOUGH MANY WON'T FIND A FREIGHTER OR REPAIR POD ALL THAT 'SEXY' COMPARED TO THE WARSHIPS, THESE SHIPS DO MUCH MORE TO FLESH OUT THE FEDERATION'S FLEET, SHOWING HOW IT WORKS, AND HOW IT STAYS TOGETHER.

I WOULD LIKE TO THANK THE MANY PEOPLE WHO HAVE OFFERED THEIR CONTINUED SUPPORT FOR THESE PROJECTS, PRIMARILY THOSE WHO HAVE VOLUNTEERED THEIR DESIGNS AND OFFERED SUGGESTIONS ON WHAT TO PUT IN (AND WHAT TO LEAVE OUT) IN THIS AND FUTURE VOLUMES. *STAR TREK* WOULDN'T HAVE LASTED BEYOND 1969 IF IT WEREN'T FOR CREATIVE FANS LIKE THESE.

NEALE DAVIDSON, MAR 2005

## STARSHIP DESIGN CREDITS

CLASS F SHUTTLE: MATTHEW JEFFERIES FOR *STAR TREK*, DESILU PRODUCTIONS

CLASS H TRAVEL POD: MICHEAL PROBERT FOR *STAR TREK: THE MOTION PICTURE*, PARAMOUNT PICTURES, INC.

CLASS E SHUTTLE: RICK STERNBACH FOR *STAR TREK: THE NEXT GENERATION*, PARAMOUNT PICTURES, INC.

CONSOLATION CLASS: JOHN PAYNE FOR *INPAYNE MODELS*.

DERF CLASS: DANA KNUTSON FOR *STAR TREK ROLE-PLAYING GAME*, FASA, INC.

HOPI, INDEPENDENCE, SHERMAN CLASS, CLASS HF SHUTTLE, CLASS AF SHUTTLE, CLASS L SHUTTLE: DON CHRISTIANSON FOR *STAR TREK: THE ANIMATED SERIES*, FILMATION PRODUCTIONS, INC.

MANHATTAN CLASS: HARRY DODDEMA FOR *TITAN FLEETYARDS*

PTOLEMY CLASS, TRANSPORT CONTAINER PODS: FRANZ JOSEPH FOR *STAR TREK: TECHNICAL MANUAL*, BALLANTINE BOOKS, INC.

*STAR TREK*, *STARSHIP ENTERPRISE*, *CONSTITUTION CLASS*, AND RELATED LIKENESSES ARE COPYRIGHTS AND TRADEMARKS OF PARAMOUNT PICTURES, INC. THIS GUIDE HAS BEEN ESTABLISHED FOR INFORMATIONAL AND ENTERTAINMENT PURPOSES ONLY. NO INFRINGEMENT OF COPYRIGHT OR TRADEMARK IS INTENDED.

**CONTENTS**

SHIPS OF SUPPORT - 2268

INTRODUCTION			PG 02:04:04
PTOLEMY CLASS	TRANSPORT/TUG	NCC 800-814	PG 02:04:5
MANHATTAN CLASS	TRANSPORT	NCC 930-934	PG 02:04:7
SHERMAN CLASS	FREIGHTER	NCC 935-939	PG 02:04:9
INDEPENDENCE CLASS	ARMED FREIGHTER	NCC 940-945	PG 02:04:11
DERF CLASS	TENDER	NCC 1270-1289	PG 02:04:13
CONSOLATION CLASS	MOBILE HOSPITAL	NCC 1424	PG 01:04:15
HOPI CLASS	LARGE SURVEYOR	NCC 1430-1434	PG 01:04:17
MONTOJO CLASS	TRANSPORT/TUG	NCC 1590-1599	PG 01:04:19
TRANSPORT POD OVERVIEW			PG 01:04:21
PRODUCTS TRANSPORT POD			PG 01:04:22
REEFER TRANSPORT POD			PG 01:04:22
DRY BULK TRANSPORT POD			PG 01:04:23
LIQUIDS TRANSPORT POD			PG 01:04:23
STARLINER TRANSPORT POD			PG 01:04:24
COLONIST TRANSPORT POD			PG 01:04:24
MOBILE REPAIR POD			PG 01:04:25
SHUTTLECARRIER POD			PG 01:04:25
DEUTERIUM FUEL POD			PG 02:04:26
TROOP TRANSPORT POD			PG 02:04:26
CLASS F SHUTTLE			PG 02:04:27
CLASS H TRAVEL POD			PG 02:04:28
CLASS HF SHUTTLE			PG 02:04:29
CLASS E SHUTTLE			PG 02:04:30
CLASS AF SHUTTLE			PG 02:04:31
CLASS L SHUTTLE			PG 02:04:32
CONSTITUTION CLASS TIMELINE			PG 02:04:33
SHUTTLECRAFT COMPARISON			PG 02:04:34
STARSHIP COMPARISON			PG 02:04:35

## INTRODUCTION

IT'S PERHAPS UNDERSTANDABLE THAT WHEN A CADET IS ASKED TO NAME ANY VESSEL FROM STARFLEET, IT'S LIKELY TO BE ONE OF THE *CONSTITUTION*, *BATON ROUGE*, OR PERHAPS *MIRANDA* CLASSES. OF COURSE, EVERY EXPERIENCED STARFLEET OFFICER KNOWS THAT A FLEET CANNOT SURVIVE WITHOUT ITS LIFELINE. BEHIND THE LEGENDARY EXPLOITS OF THE STARSHIP *ENTERPRISE* ARE A NUMBER OF SUPPORT VESSELS, THE TENDERS, FREIGHTERS, AND SUPPLY SHIPS THAT HELP KEEP THE SHIPS OF THE LINE GOING, HELP FEED HUNGRY COLONISTS, AND BUILD UP THE BACKBONE THAT IS STAR FLEET.

THOUGH THEIR ROLES ARE FAR FROM GLAMOROUS, THE SERVICES OF THE *PTOLEMY*, *HURON*, AND VESSELS LIKE THEM CANNOT BE IGNORED OR UNDERESTIMATED. AFTER ALL, A HUNGRY COLONIST WILL USUALLY NEED A SHIPMENT OF QUADROTRITICALE FROM A FREIGHTER MUCH MORE THAN THEY NEED PHOTON TORPEDO SUPPORT FROM ONE OF OUR HEAVY CRUISERS.

ANOTHER THING THAT SHOULD BE NOTICED IS THAT THIS VOLUME ONLY CONTAINS AUXILIARY VESSELS AUTHORIZED EXPLICITLY BY STARFLEET COMMAND. THE FEDERATION MAKES USE OF MANY VARIETIES OF SHIPS FOR SUPPORT PURPOSES, RANGING FROM TRANSPORTS, STRATEGIC DEPLOYMENT, AND REPAIR SERVICES. STARFLEET DATABASES WILL OFFER MORE COMPLETE INFORMATION ON THE AUXILIARY AND CIVILIAN COMPONENTS OF THE FEDERATION SUPPORT FLEET.

ADMIRAL NOGURA  
CHIEF OF OPERATIONS, STARFLEET  
UNITED FEDERATION OF PLANETS  
STARDATE 7696.00

**CLASS I TRANSPORT/TUG**

PTOLEMY CLASS STARSHIPS

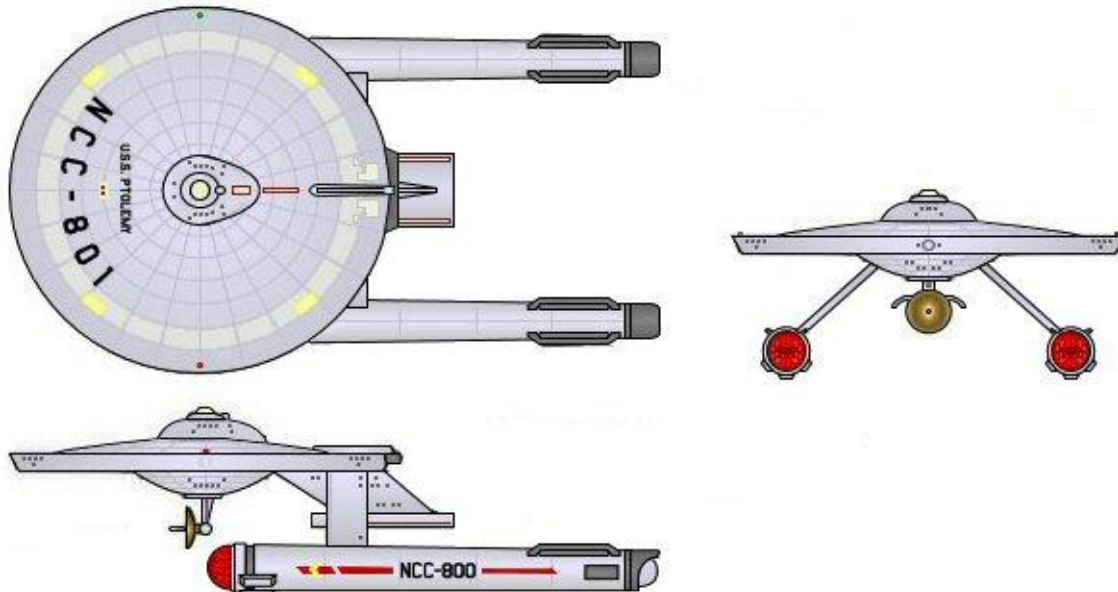

**CLASS NAME:** PTOLEMY  
**CLASS DESIGNATION:** TRANSPORT/TUG, CLASS I  
**CLASS COMMISSION:** 2252

**COMPLEMENT (STD):**  
**OFFICERS:** 20  
**CREW:** 175

**DRIVE SYSTEM:**  
**IMPULSE:** FID-2 (75C)  
**WARP:** FWF-I, TANDEM, (WF 6/8)

**ARMAMENT (STD):**  
**PHASERS:** 1 BANK/2 EACH, TYPE FH-3  
**TORPEDOES:** 1 BANKS. TYPE FP-I

**SUPPLEMENTAL CRAFT (STD):**  
**CLASS H TRAVEL POD:** 2

**DIMENSIONS:**  
**LENGTH:** 221M  
**BREADTH:** 127M  
**HEIGHT:** 67M  
**MASS (DEADWEIGHT):** 127MT

**GENERAL INFORMATION**

THE DESIGN OF THE *PTOLEMY* WAS MEANT AS A HEAVY DELIVERY SYSTEM FOR STARFLEET'S 'GENERIC TRANSPORT POD' SYSTEM. THE DESIGN ALLOWS FOR A TRANSPORT POD TO BE LOCKED INTO PLACE BENEATH THE PRIMARY HULL, ALLOWING, IN THEORY, FOR THE *PTOLEMY* TO SERVE EITHER AS A SIMPLE TRANSPORT SHIP, OR ALSO PERFORM OTHER FUNCTIONS DEPENDING ON HOW SHE WAS OUTFITTED.

THE SHIP'S PERFORMANCE CAN VARY WIDELY DEPENDING ON THE POD USED, RANGING FROM NEAR DEFENSELESS WITH A SIMPLE TRANSPORT TO NEAR CRUISER CAPABILITIES WITH A HEAVY COMBAT POD SYSTEM. THE DOWNSIDE OF THIS FLEXIBILITY, HOWEVER, IS THAT THE SPECS OF EACH ARRANGEMENT TEND TO BE SOMEWHAT LESS THAN A DEDICATED SHIP.

IN ADDITION TO THE POD SYSTEM, THE *PTOLEMY*'S POWERFUL TRACTOR BEAM ARRAY (LOCATED WITHIN AND BEHIND THE CONNECTION STRUT) CAN BE USED AS A REGULAR TUG, ENABLING THE *PTOLEMY* TO COME TO THE AID OF EVEN THE LARGEST STARSHIPS, AND EVEN SMALLER OUTPOSTS AND BASES, AND RETURN WOUNDED CRAFT BACK FOR FULL REPAIRS.

## CLASS I TRANSPORT TUG

AUTHORIZED CONSTRUCTION

THE FOLLOWING SHIPS OF THE PTOLEMY CLASS TRANSPORT/TUG HAVE BEEN AUTHORIZED AS PART OF THE FEDERATION STAR FLEET AS OF STARDATE 7712.00:

USS PTOLEMY - NCC 800*	USS HIPPARCHUS - NCC 809	USS FANCANG - NAR 1217
USS JENNINGS - NCC 801	USS ULUGH BEG - NCC 810	USS DAYUN - NAR 1218+
USS AH RASHID - NCC 802	USS PHILOLAUS - NCC 811**	SS ZUBRINSKI - NDT 986
USS ANAXAGORAS-NCC 803**	USS PYTHAGORAS - NCC 812+	SS PULKOWNIK - NDT 987
USS ANAXIMANDER - NCC 804	USS THALES - NCC 813+	SS BOLESLAW - NDT 988
USS ARISTARCHUS - NCC 805	USS HEVELIUS - NCC 814+	SS ZDROJ - NDT 989
USS IBN DAUD - NCC 806	USS SHICHANG - NAR 1214	SS WIELICZKA - NDT 990
USS ERATOSTHENES-NCC 807	USS NANCANG - NAR 1215	SS BIALOSTOCKA - NDT 991
USS GALILEI - NCC 808**	USS TAIKANG - NAR 1216	

\* CLASS SHIP, \*\* LOST IN THE LINE OF DUTY, + UNDER CONSTRUCTION AS OF STARDATE 7712.00

### EDITOR'S ANNOTATIONS

THE *PTOLEMY* FIRST APPEARED IN THE FRANZ JOSEPH *TECHNICAL MANUAL*, AND WAS MEANT TO BE THE FEDERATION'S MAINSTAY SUPPLY AND SUPPORT SHIP. THE TRANSPORT WASN'T SO MUCH DESIGNED TO TOW OTHER SHIPS, BUT INSTEAD MAKE USE OF A NUMBER OF 'TRANSPORT PODS' THAT COULD SHIP LARGE VOLUMES OF BULK GOODS, OR EVEN SERVE AS A STARLINER FOR PASSENGERS.

DESPITE ITS FAMILIARITY WITH THE FANS, THIS IS ONE OF THOSE SHIPS THAT GENE RODENBERRY DECLARED 'NON-CANON' BACK IN THE DAYS OF THE MOTION PICTURE. FOR THE PTOLEMEY, THE SUPPOSED OBJECTION TO THE DESIGN WAS THAT THE WARP ENGINES DID NOT HAVE FULL LINE OF SIGHT ON ONE ANOTHER. OF COURSE, IF THAT'S A PROBLEM, THE ON-SCREEN *SS AURORA* OR *USS GRISSOM* WOULD BE PROBLEMS AS WELL. MORE THAN THAT, THE SHIP'S SCHEMATICS APPEAR IN THREE OF THE FEATURE FILMS.

THIS GUIDE USES ONLY MOST OF THE FIRST 'BATCH' FROM THE *TECHNICAL MANUAL* AS MEMBERS OF THE *PTOLEMY* CLASS, STRIPPING DOWN ITS NUMBERS TO SOMETHING MORE REASONABLE. THE REGISTRATION NUMBERS HAVE ALSO BEEN ALTERED (LARGELY JUST DROPPING THE INITIAL '3' FROM EACH) TO BRING THE DESIGN IN LINE WITH THE REST OF FLEET'S REGISTRIES.

THE 'NAR' SHIPS, OR AUXILLARY RESERVES, ARE NAMED AF-

TER CONTEMPORARY CHINESE SUPPORT VESSELS OF VARIOUS TYPES. THE 'GENERAL USE' TRANSPORTS ARE NAMED AFTER CONTEMPORARY POLISH FREIGHTERS.

**CLASS I TRANSPORT**

MANHATTAN CLASS STARSHIPS

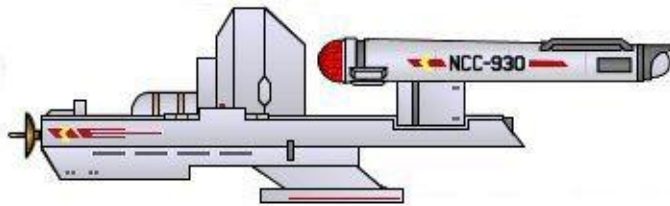
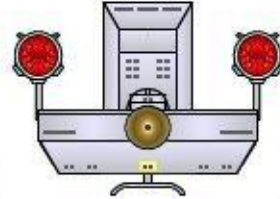
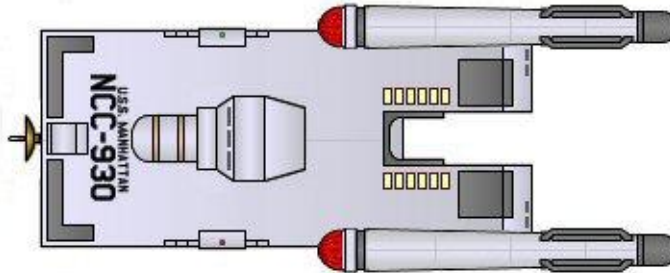

**CLASS NAME:** MANHATTAN  
**CLASS DESIGNATION:** TRANSPORT, CLASS I-A  
**CLASS COMMISSION:** 2249

**COMPLEMENT (STD):**  
**OFFICERS:** 5  
**CREW:** 25  
**AUTOMATION POSSIBLE**

**DRIVE SYSTEM:**  
**IMPULSE:** FID-2 (75C)  
**WARP:** FWF-IS, TANDEM, CWF 5/7)

**ARMAMENT (STD):**  
**PHASERS:** 1 BANKS/2 EACH, TYPE FH-3  
**TORPEDOES:** NONE

**SUPPLEMENTAL CRAFT (STD):**  
**CLASS H TRAVEL POD:** 2

**DIMENSIONS:**  
**LENGTH:** 225M  
**BREADTH:** 95M  
**HEIGHT:** 69M  
**MASS (DEADWEIGHT):** 132MT

**GENERAL INFORMATION**

THE *MANHATTAN* IS AN AGING DESIGN, BUT ONE STILL WELL CAPABLE OF PERFORMING ITS INTENDED MISSION, WITH OR WITHOUT CREW, WITH DOGGED DETERMINATION. THE *MANHATTAN* WAS DESIGNED TO MAKE USE OF THE NEW AUTOMATION SYSTEMS AVAILABLE, AND PERFORM GENERAL SUPPLY DUTIES IN AREAS EITHER TOO DANGEROUS TO RISK A FULL CREW, OR IN ROUTES SO SECURE THAT CREWING THE SHIP WAS NOT NECESSARY.

AS ONE OF A HANDFUL OF MODERN AUTOMATED DESIGNS, THE *MANHATTAN* HAS ONE BASIC ADVANTAGE IN THAT IT'S THE ONLY POTENTIALLY AUTOMATED DESIGN AVAILABLE WHICH CAN MAKE USE OF THE STANDARD STARFLEET TRANSPORT PODS, ALLOWING A WIDE VARIETY OF FREIGHT AND SUPPLIES TO BE SHIPPED WITH A MINIMAL OF CREW.

STAR FLEET KEEPS VERY FEW OF THIS CLASS OF SHIP FOR ITSELF, INSTEAD PREFERRING TO USE EITHER THE MORE VENERABLE *PTOLEMY* CLASS VESSELS FOR DEDICATED MILITARY PURPOSES. HOWEVER, FLEET MAINTAINS A LARGER NUMBER OF THESE VESSELS AS AUXILIARIES, AND ALSO HAS LICENSED OUT A SIMILAR DESIGN (WITH DECLASSIFIED COMPONENTS) TO CIVILIAN AGENCIES.

STARFLEET IS CONSIDERING RETIRING THIS OLD CLASS OF VESSEL, AND REPLACING HER NUMBER WITH NEW TRANSPORT/TUGS OF THE UPCOMING 'REFIT' *PTOLEMY* CLASS.

**CLASS I TRANSPORT**

AUTHORIZED CONSTRUCTION

THE FOLLOWING SHIPS OF THE MANHATTAN CLASS TRANSPORT HAVE BEEN AUTHORIZED AS PART OF THE FEDERATION STAR FLEET AS OF STARDATE 7712.00:

USS MANHATTAN - NCC 930*	USS TUTANKHAMEN - NAR 1209	SS DIAMANTIS - NDT 981
USS SCARSDALE - NCC 931	USS IMHOTEP - NAR 1210	SS FALLIOPI - NDT 982
USS NOPATIN - NCC 932	USS KHUFU' - NAR 1211	SS TATIANGELA - NDT 983**
USS SHEKARD- NCC 933	USS SNOFRU - NAR 1212	SS STAVRONIKITA - NDT 984
USS SHRASS - NCC 934	USS KHUFU - NAR 1213	SS YANIX - NDT 985

\* CLASS SHIP, \*\* LOST IN THE LINE OF DUTY, + UNDER CONSTRUCTION AS OF STARDATE 7712.00

**EDITOR'S ANNOTATIONS**

THE *MANHATTAN* IS SOMEWHAT LOOSELY BASED ON HARRY DODDEMA'S SHIP OF THE SAME NAME FROM *TITAN FLEETYARD YARDS*. THAT SHIP WAS LISTED AS, BASICALLY, AN AUTOMATED VERSION OF THE *PTOLEMY*, USING LINES FROM SHIPS SHOWN IN *STAR TREK: THE ANIMATED SERIES*.

THE VERSION HERE KEEPS THE SAME CONCEPT, BUT ALTERS THE LINES TO KEEP IT SIMILAR TO THE AUTOMATED *USS SHERMAN* SHOWN IN THE SERIES. THE SHIP'S NAME AND REGISTRY MARKINGS ARE ALTERED TO MAKE THE SHIP MORE CONTEMPORARY WITH THE REST OF THE FLEET.

THE 'NAR' SHIPS, OR AUXILLARY RESERVES, ARE NAMED AFTER THE PYRAMID BUILDERS OF ANCIENT EGYPT. THE 'GENERAL USE' TRANSPORTS ARE NAMED AFTER CONTEMPORARY GREEK FREIGHTERS.



**CLASS I FRIEGHTER**

SHERMAN CLASS STARSHIPS

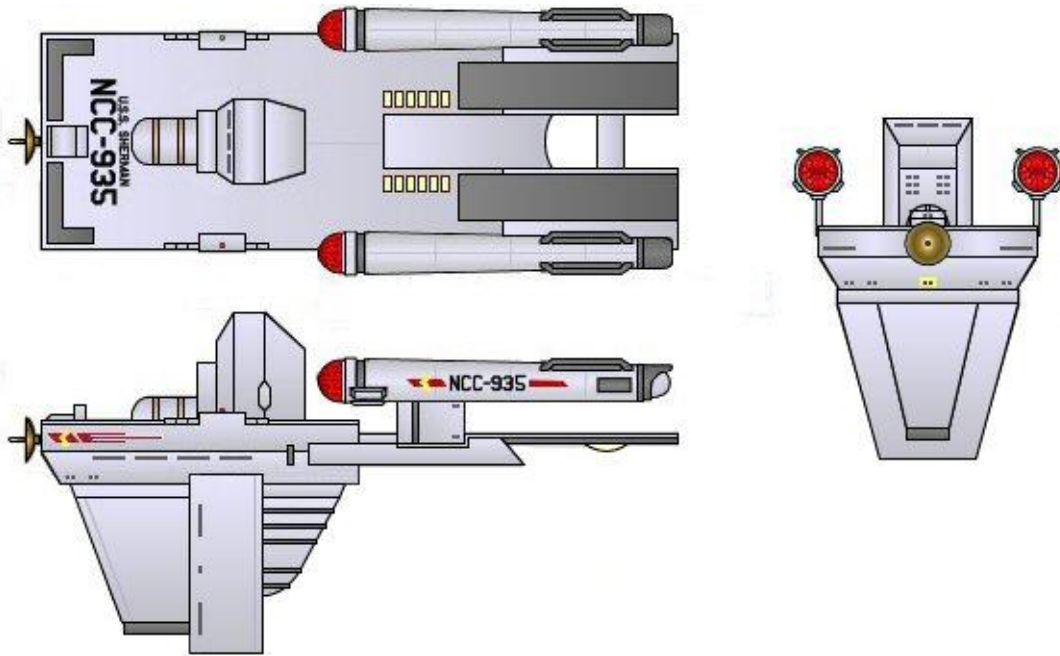

**CLASS NAME:** SHERMAN  
**CLASS DESIGNATION:** FREIGHTER, CLASS I-A  
**CLASS COMMISSION:** 2247

**COMPLEMENT (STD):**  
**OFFICERS:** 5  
**CREW:** 25  
**AUTOMATION POSSIBLE**

**DRIVE SYSTEM:**  
**IMPULSE:** FID-2 (75C)  
**WARP:** FWF-IS, TANDEM, (WF 5/7)

**ARMAMENT (STD):**  
**PHASERS:** 1 BANKS/2 EACH, TYPE FH-3  
**TORPEDOES:** NONE

**SUPPLEMENTAL CRAFT (STD):**  
**CLASS H TRAVEL POD:** 2

**DIMENSIONS:**  
**LENGTH:** 227M  
**BREADTH:** 95M  
**HEIGHT:** 120M  
**MASS (DEADWEIGHT):** 160MT

**GENERAL INFORMATION**

AS EXPECTED FROM A LARGELY AUTOMATED SHIP CLASS, THE *SHERMAN* IS AN AGING DESIGN. THIS DESIGN, HOWEVER, WAS CONSTRUCTED WITH HER EVENTUAL OBSOLENCE IN MIND. AS A AUTOMATED FREIGHTER, THE *SHERMAN* CAN PERFORM ROUTINE, MUNDANE MISSIONS UNDER HER OWN PROGRAMMING, OR BE DIRECTED BY AN 'ESCORT SHIP' VIA SUBSPACE LINK FOR HAZARDOUS DUTIES.

STARFLEET MAINTAINS A SMALL NUMBER OF THESE FREIGHTERS IN ACTIVE DUTY, LARGELY TO SERVICE AND SUPPLY OUTPOSTS AND STARBASES. THE BULK OF THE SHIPS OF THIS TYPE ARE UNDER CIVILIAN ARRANGEMENTS OR SLATED AS RESERVES. THE SINGLE PHASER BANK FOUND ON THE STARFLEET VERSION OF THE SHIP IS NOT AVAILABLE ON THE CIVILIAN VERSION, AND IS DISABLED FOR ANY AUTOMATED USE.

THOUGH THE AGE OF THE *SHERMAN*'S ACTUAL DESIGN IS NOW WELL OVER, THE CLASS WILL LIKELY CONTINUE TO SEE SERVICE FOR DECADES TO COME, THOUGH INCREASINGLY IN 'AUTOMATED ONLY' ROLES. SURPRISINGLY, HOWEVER, A NEW VERSION OF THE SHIP IS BEING CONSIDERED FOR A PURELY CIVILIAN DESIGN, BASED ON DECLASSIFIED FEDERATION TECHNOLOGY.

## CLASS I FREIGHTER

AUTHORIZED CONSTRUCTION

THE FOLLOWING SHIPS OF THE SHERMAN CLASS FREIGHTER HAVE BEEN AUTHORIZED AS PART OF THE FEDERATION STAR FLEET AS OF STARDATE 7712.00:

USS SHERMAN - NCC 935*	USS SANDRA - NAR 1201	SS CAMPONALON - NGL 1463**
USS VON DRAKE - NCC 936	USS MAYAGUEZ - NAR 1202	SS ALECIA - NGL 1464**
USS PEABODY - NCC 937	USS SULPHUR QUEEN-NAR 1203	SS VICTORIA ELENA-NGL 1465
USS NELL - NCC 938**	SS GAMESA - NGL 1460	SS VILLA DE ORIO - NGL 1466
USS DUDLEY - NCC 939	SS KHRON - NGL 1461**	SS URLEA- NGL 1467
USS YAMHILL - NAR 1200	SS PUENTE CANARIO-NGL 1462	

\* CLASS SHIP, \*\* LOST IN THE LINE OF DUTY, + UNDER CONSTRUCTION AS OF STARDATE 7712.00

### EDITOR'S ANNOTATIONS

THE *SHERMAN* CLASS WAS SHOWN IN THE *STAR TREK: ANIMATED SERIES* EPISODE 'MORE TRIBBLES, MORE TROUBLES'. TWO OF THESE VESSELS WERE SHOWN, WITH SLIGHTLY DIFFERENT REGISTRIES THAN SHOWN HERE, AND WERE SEVERELY DAMAGED BY A KLINGON CRUISER. THE *SHERMAN* CLASS NAME COMES BOTH AS A REFERENCE TO 'SHERMAN'S PLANET', REFERENCED IN THE EPISODE, AND ALSO TO THE 'PEABODY'S IMPROBABLE HISTORY' SHORTS RUNNING ON TELEVISION AT THE TIME.

THE *SHERMAN* WAS ONE OF ONLY THREE STARFLEET SHIP CLASSES SHOWN IN THE 'ORIGINAL SERIES' ERA. THE SCALE OF THE SHIP IS IN SOME QUESTION, SINCE VARIOUS SHOTS HAD THE SHIP EITHER LARGER OR SMALLER THAN THE *ENTERPRISE*. THE ASSUMPTION HERE IS THAT IT'S A LITTLE BIT SMALLER, THOUGH STILL LARGE ENOUGH TO SERVE AS A BULK FREIGHTER AS COMPARED TO THE *ENTERPRISE*'S ROLE AS A HEAVY CRUISER.

THE SHIP ALSO BEARS SOME DISTINCTION IN THAT, DESPITE BEING COMPLETELY AUTHORIZED BY GENE RODDENBERRY AT THE TIME OF *STAR TREK: THE ANIMATED SERIES*, IT HAS SINCE BEEN CLASSIFIED AS 'NON-CANON' BECAUSE THE AUTOMATED BRIDGE MODULE DOES NOT MATCH THE BRIDGE MODULES OF 'OFFICIAL' STARSHIPS. THIS GUIDE JUST ASSUMES THAT THE AUTOMATED-POSSIBLE SHIPS HAD A DIFFERENT DESIGN CRITERIA IN MIND THAN THE BULK OF THE FLEET.

THE LINES HERE, FROM THE TOP VIEW, ARE A BIT DIFFERENT THAN THE APPEARANCE AS SHOWN ON THE SERIES. THIS IS LARGELY BECAUSE THE LINES DON'T MATCH UP ALL THAT WELL IN THE VARIOUS SHOTS, AND THE MORE PREVALENT SIDE VIEW WAS GIVEN PRECEDENCE. THE 'CORRECTIONS' MADE WERE DONE TO BRING THE DESIGN MORE IN LINE WITH THE REST OF THE FLEET.

THE 'NAR' SHIPS, OR AUXILLARY RESERVES, ARE NAMED AFTER VARIOUS AMERICAN FREIGHTERS IN MODERN HISTORY. THE 'GENERAL FREIGHT' SHIPS, THOSE WITH THE 'NGL' REGISTRIES, ARE NAMED AFTER SPANISH FREIGHTERS.

## CLASS I ARMED FRIEGHTER

INDEPENDENCE CLASS STARSHIPS

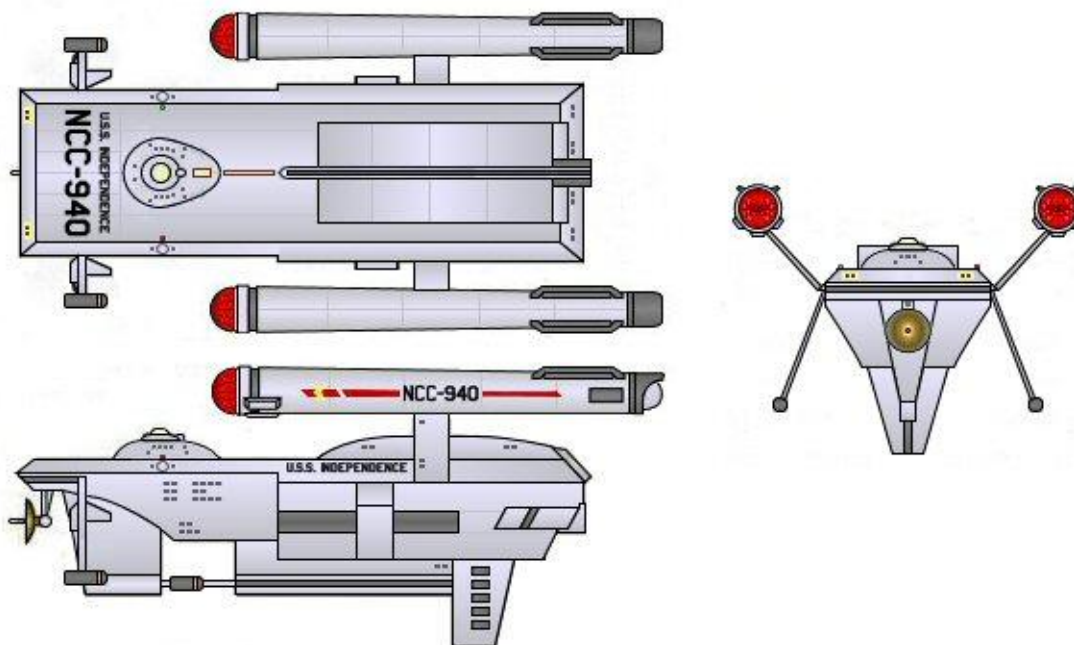

**CLASS NAME:** INDEPENDENCE  
**CLASS DESIGNATION:** ARMED FREIGHTER, CLASS I  
**CLASS COMMISSION:** 2252

**COMPLEMENT (STD):**  
**OFFICERS:** 7  
**CREW:** 35

**DRIVE SYSTEM:**  
**IMPULSE:** FID-2 (75C)  
**WARP:** FWF-I, TANDEM, (WF 6/8)

**ARMAMENT (STD):**  
**PHASERS:** 2 BANKS/2 EACH, TYPE FH-3

**SUPPLEMENTAL CRAFT (STD):**  
**CLASS H TRAVEL POD:** 2

**DIMENSIONS:**  
**LENGTH:** 221M  
**BREADTH:** 112M  
**HEIGHT:** 98M  
**MASS (DEADWEIGHT):** 185MT

### GENERAL INFORMATION

THOUGH THE FEDERATION AND KLINGON EMPIRE ARE UNDER TREATY TO AVOID OPEN WARFARE, COLONIES AND OUT-POSTS WITHIN THE NEUTRAL ZONE ARE IN NEED OF CONSTANT SUPPLY AS WELL AS CONSTANT DANGER OF RAIDS. THE *INDEPENDENCE* CLASS ARMED FREIGHTER IS LARGELY USED TO SUPPLY GOODS AND MATERIALS INTO AREAS KNOWN FOR HOSTILITIES, WHERE IT'S NOT ADVISABLE FOR CIVILIAN SHIPS TO GO WITHOUT ESCORT.

THOUGH THE *INDEPENDENCE* IS, BY NO MEANS, A VESSEL MEANT FOR COMBAT, HER TWO PHASER BANKS HAS CAUSED MORE THAN ONE WOULD-BE RAIDER TO RECONSIDER TARGETING THESE ARMED FREIGHTERS AS PREY. NOT TRULY DESIGNED TO WIN A CONFLICT, THE FREIGHTER WAS DESIGNED TO WITHSTAND AN ATTACK UNTIL HELP CAN ARRIVE. FOR FREIGHTERS, THE *INDEPENDENCE* CLASS CAN WITHSTAND A TREMENDOUS POUNDING.

THOUGH THE CLASS IS NEARING THE END OF ITS TECHNOLOGICAL HEY-DEY, THE CLASS REMAINS A FAVORITE WITHIN THE NEUTRAL ZONE AND LIKELY WON'T BE COMPLETELY PHASED OUT FOR A NUMBER OF YEARS. A NEW CLASS, BASED ON THE *ARCHERINAR PROJECT*, IS SCHEDULED TO REPLACE THE DESIGN IN 2273.

## CLASS I ARMED FREIGHTER

AUTHORIZED CONSTRUCTION

THE FOLLOWING SHIPS OF THE INDEPENDENCE CLASS ARMED FREIGHTER HAVE BEEN AUTHORIZED AS PART OF THE FEDERATION STAR FLEET AS OF STARDATE 7712.00:

USS INDEPENDENCE-NCC 940*	USS DURANCE - NAR 1205	SS NORKOVA - NFT 1912
USS BLUE CITY - NCC 941	USS SUCCESS - NAR 1206	SS HURON - NFT 1913
USS BRANSON - NCC 942	USS HERON BAY - NAR 1207	SS OREGON TRAIL - NFT 1914
USS KANSAS CITY-NCC 943	USS SOMME - NAR 1208	SS DEIDRE - NFT 1915
USS SAINT PETERS-NCC 944	USS MARNE - NAR 1209+	SS KITTY HAWK - NFT 1916
USS BELTON- NCC 945	SS ASTRAL QUEEN - NFT 1910	SS NORTHERN STAR-NFT 1917
USS WESTRALIA - NAR 1204	SS BONNE CHANCE - NFT 1911	

\* CLASS SHIP, \*\* LOST IN THE LINE OF DUTY, + UNDER CONSTRUCTION AS OF STARDATE 7712.00

### EDITOR'S ANNOTATIONS

THE *INDEPENDENCE* CLASS WAS SHOWN IN THE *STAR TREK: ANIMATED SERIES* EPISODE 'PIRATES OF ORION'. THE VESSEL SHOWN WAS THE 'SS HURON', OR 'USS HURON', DEPENDING ON THE DIALOGUE OR WHAT THE ANIMATED CELL WAS SHOWING. IT HAD BEEN UP IN THE AIR IF THE *HURON* WAS A STARFLEET OR INDEPENDENT SHIP.

THE *HURON* HERE IS GIVEN THE REGISTRY 'NGL 1913', MAKING IT FIT MORE THE ACCEPTED 'LATER-DAY' METHOD OF ASSIGNING REGISTRIES. ORIGINALLY, SHE WAS ASSIGNED 'NCC-F1913', WITH 'F' STANDING IN FOR FREIGHTER.

THE *HURON* WAS ONE OF ONLY THREE STARFLEET SHIP CLASSES SHOWN IN THE 'ORIGINAL SERIES' ERA. THE SCALE OF THE SHIP IS IN SOME QUESTION, SINCE VARIOUS SHOTS HAD THE SHIP EITHER LARGER OR SMALLER THAN THE *ENTERPRISE*. THE ASSUMPTION HERE IS THAT IT'S A LITTLE BIT SMALLER, THOUGH STILL LARGE ENOUGH TO SERVE AS A BULK FREIGHTER AS COMPARED TO THE *ENTERPRISE*'S ROLE AS A HEAVY CRUISER.

THE LINES HERE, FROM THE TOP VIEW, ARE A BIT DIFFERENT THAN THE APPEARANCE AS SHOWN ON THE SERIES. MOST OF THE LINES ARE TAKEN FROM *THE ANIMATED SERIES*, BUT THE UNUSUAL TWIN-WINDOW BRIDGE DESIGN HAS BEEN REPLACED WITH THE MORE STANDARD FEDERATION BRIDGE DOME. THIS IS JUST IN KEEPING WITH THE 'FEDERATION RULES' GIVEN OUT

FOR STARSHIP DESIGN.

THE 'NAR' SHIPS, OR AUXILLARY RESERVES, ARE NAMED AFTER VARIOUS RESUPPLY SHIPS IN MODERN HISTORY. THE 'GENERAL FREIGHT' SHIPS, THOSE WITH THE 'NFT' REGISTRIES, ARE NAMED AFTER SHIPS MENTIONED IN ONE OF THE VARIOUS *STAR TREK* SERIES.

**CLASS I TENDER**

DERF CLASS STARSHIPS

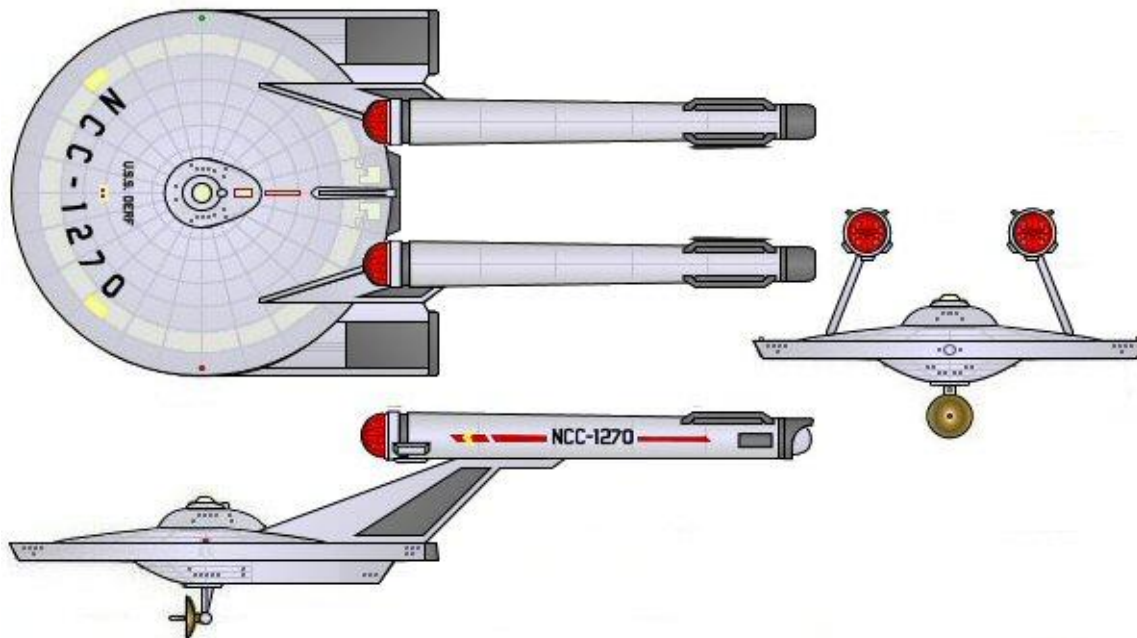

**CLASS NAME:** DERF  
**CLASS DESIGNATION:** TENDER, CLASS I  
**CLASS COMMISSION:** 2258

**COMPLEMENT (STD):**  
**OFFICERS:** 32  
**CREW:** 145

**DRIVE SYSTEM:**  
**IMPULSE:** FID-2 (75C)  
**WARP:** FWF-I, TANDEM, (WF 6/8)

**ARMAMENT (STD):**  
**PHASERS:** 1 BANKS/2 EACH, TYPE FH-3

**SUPPLEMENTAL CRAFT (STD):**  
**CLASS H TRAVEL POD:** 2

**DIMENSIONS:**  
**LENGTH:** 273M  
**BREADTH:** 127M  
**HEIGHT:** 80M  
**MASS (DEADWEIGHT):** 85MT

**GENERAL INFORMATION**

CALLING THE *DERF* CLASS A TENDER MIGHT BE A LITTLE MISLEADING. WHILE THE SHIP'S PRIMARY ROLE IS INDEED TO SUPPLY AND MAINTAIN SHIPS AND BASES IN THE FIELD, THE *DERF* HAS BECOME AN ALL AROUND SOLID-PERFORMER IN A VARIETY OF FIELDS. IT'S NOT THAT UNUSUAL TO SEE A *DERF* CLASS SHIP PERFORMING SUVEY MISSIONS, SCIENTIFIC RE-SEARCH, OR EVEN BORDER PATROL AS PART OF SMALL FLEET ACTIONS.

THE EXPANDED SECTION OF THE 'SAUCER' IS RESERVED FOR CARGO AND STORAGE USE, ABLE TO CARRY DUETRONIUM FUEL, REGULAR STORES, ETC, DEPENDING ON THE SPECIFIC MISSION NEEDS. THE *DERF* IS ALSO EQUIPPED WITH A LARGER-THAN-NORMAL ASSORTMENT OF TRANSPORTER BAYS TO FACILITATE LOADING AND UNLOADING OF SUPPLIES.

VITH HER VERSATILITY, MANY IN STARFLEET FEEL THAT IF HER ARMAMENT WAS HEAVIER, SHE MAY QUALIFY AS A LIGHT FRIGATE RATHER THAN A TENDER. THERE IS SOME DEBATE ON WETHER TO RECLASSIFY THE UPCOMING 'REFIT DESIGN' OF THE *DERF* AS IN RECOGNITION OF THE CLASS'S VARIED-ROLE PERFORMANCE.

**CLASS I TENDER**

AUTHORIZED CONSTRUCTION

THE FOLLOWING SHIPS OF THE DERF CLASS TENDER HAVE BEEN AUTHORIZED AS PART OF THE FEDERATION STAR FLEET AS OF STARDATE 7712.00:

USS DERF - NCC 1270*	USS ARCTIC - NCC 1279	USS CONCORDE - NCC 1288+
USS POLYNESIAN - NCC 1271**	USS BRIDGE - NCC 1280	USS SAN JOSE - NCC 1289+
USS BEOWULF - NCC 1272	USS KILAUEA - NCC 1281	USS KANAWHA - NAR 1219
USS SPEAR - NCC 1273	USS SANTA BARBARA-NCC 1282	USS PECOS - NAR 1220
USS ACROPOLIS - NCC 1274**	USS FLINT - NCC 1283**	USS BIG HORN - NAR 1221
USS EMORY LAND - NCC 1275	USS SHASTA - NCC 1284**	USS PATUXTENT - NAR 1222
USS CABLE - NCC 1276	USS MOUNT BAKER - NCC 1285	USS LARAMIE - NAR 1223
USS SUPPLY - NCC 1277	USS KISKA - NCC 1286+	USS GADUALUPE - NAR 1224+
USS RAINER - NCC 1278	USS NIAGARA - NCC 1287+	USS RAPPAHANNOCK-NAR 1225+

\* CLASS SHIP, \*\* LOST IN THE LINE OF DUTY, + UNDER CONSTRUCTION AS OF STARDATE 7712.00

**EDITOR'S ANNOTATIONS**

EVEN BY FASA STANDARDS, THE *DERF* IS A BIT OF A BIZARRE SHIP. IT'S NOT BAD IN DESIGN, BUT IT'S HISTORY IS VERY STRANGE. IN THE ORIGINAL RELEASE OF FASA'S *STAR TREK: THE ROLE-PLAYING GAME*, THE *DERF* WAS LISTED AS A 'SURVEYOR', AND IT WAS ASSUMED THAT THE *ANTARES*, *BEAGLE*, ETC, WERE SHIPS OF THIS CLASS. IN OTHER WORDS, THE *DERF* WAS A HEAVY FIELD SCOUT.

COME THE NEXT EDITION OF THE GAME, THE DESIGNATION OF THE *DERF* WAS COMPLETELY REWRITTEN, MAKING HER A TENDER. OF COURSE, FOR A TENDER, SHE'S WAS HEAVILY ARMED. THE VERSION HERE REDUCES THE NUMBER OF WEAPONS THAT THE *DERF* CARRIES WITH HER.

VISUALLY, THE SHIP HERE IS LITTLE DIFFERENT FROM THE ONE PRESENTED IN FASA. THE ONLY ADDITION IS SOME ADDED LINE DETAIL TO THE REAR SECTIONS OF THE HULL, AND A PRIMARY DEFLECTOR DISH, AS PER 'FRANZ JOSEPH'S' DESIGNS.

MOST OF THE SHIP NAMES FOR THE REGISTRY LIST COME FROM VARIOUS SUPPLY AND MAINTENANCE SHIPS WITHIN THE CONTEMPORARY US NAVY. THE 'DERF' AND THE 'ACROPOLIS' ARE THE TWO SHIPS NAMED AS WITHIN THE CLASS BY FASA.

**CLASS I MOBILE HOSPITAL**

CONSOLATION CLASS STARSHIPS

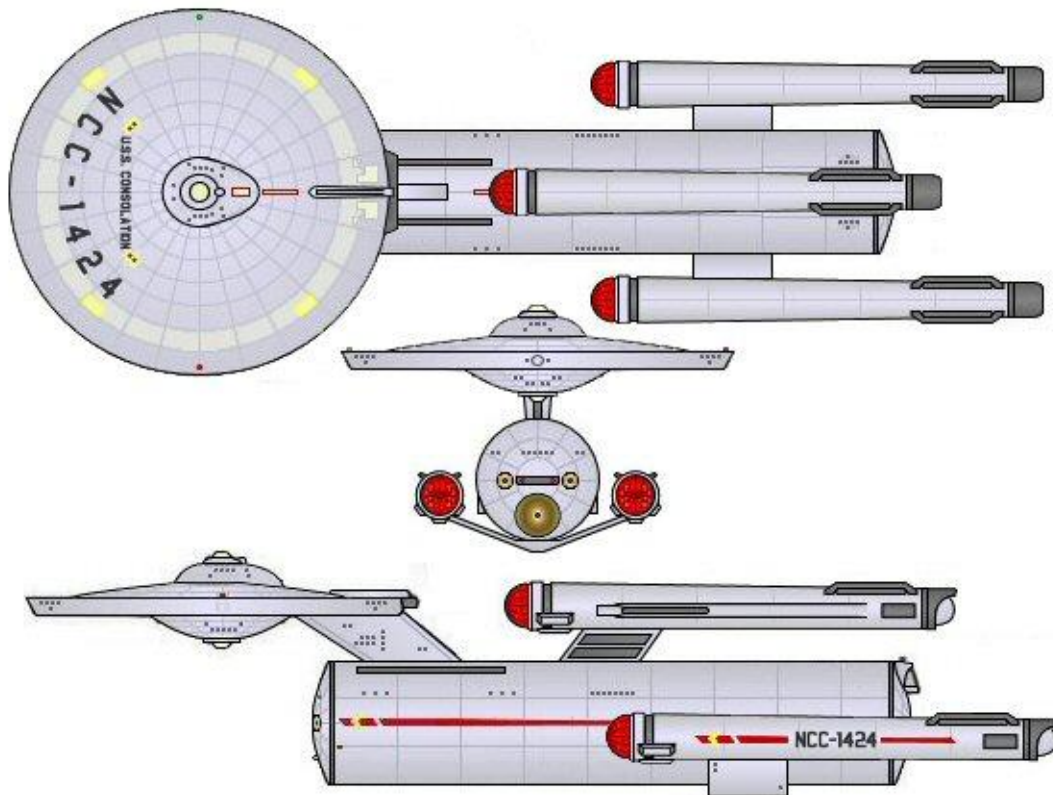

**CLASS NAME:** CONSOLATION  
**CLASS DESIGNATION:** MOBILE HOSPITAL, CLASS I  
**CLASS COMMISSION:** 2263

**COMPLEMENT (STD):**  
**OFFICERS:** 45  
**CREW:** 520

**DRIVE SYSTEM:**  
**IMPULSE:** FID-2 (75C)  
**WARP:** FWF-I, TANDEM, (WF 6/8)  
**WARP:** FWF-I, SINGLE-EM (WF 5/7)

**ARMAMENT (STD):**  
**PHASERS:** 2 BANKS/2 EACH, TYPE FH-3

**SUPPLEMENTAL CRAFT (STD):**  
**CLASS F SHUTTLECRAFT:** 6  
**CLASS HF SHUTTLECRAFT:** 4  
**CLASS H TRAVEL POD:** 4

**DIMENSIONS:**  
**LENGTH:** 350M  
**BREADTH:** 127M  
**HEIGHT:** 86M  
**MASS (DEADWEIGHT):** 315MT

**GENERAL INFORMATION**

THE *CONSOLATION* BEARS THE DISTINCTION OF BEING THE LARGEST CLASS OF FEDERATION SHIP TO PASS THROUGH APPROPRIATIONS WITHOUT A DISSENTING VOTE. IT IS, OF COURSE, NO WONDER. THE *CONSOLATION* IS A WARP-CAPABLE FULLY-STAFFED, FULLY-FUNCTIONAL HOSPITAL, A SERVICE VITALLY NEEDED THROUGH THE FEDERATION FRONTIER, AND ULTIMATELY HUMANITARIAN.

THE *CONSOLATION* HAS FACILITIES TO TREAT UP TO TWO THOUSAND PATIENTS IN EMERGENCY SITUATIONS, AS WELL AS AMPLE TRANSPORTERS AND SHUTTLE USE FOR QUICK RESCUE AND EVACUATION SYSTEMS. TACTICALLY, THE SHIP IS LIGHTLY ARMED BUT HEAVILY SHIELDED. A REDUNDANT WARP DRIVE ENGINE CAN ALSO BE USED AS AN EMERGENCY BACK UP IN CASE THE MAIN ENGINES FAIL.

STARFLEET FIELDS ONLY RETAINS THE *CONSOLATION* HERSELF FROM THIS CLASS, PRIMARILY FOR COLONY SUPPORT. THE REMAINING VESSELS ARE ALL RESERVISTS. RELIGIOUS GROUPS FROM SEVERAL FEDERATION WORLDS VOLUNTEER FOR LONG ASSIGNMENTS ABOARD HOSPITAL SHIPS, IN FULFILLMENT OF THEIR SPIRITUAL DUTIES. [WHILE THIS SERVICE IS MORE THAN WELCOME, STARFLEET REGULATIONS DO FORBID PROSTELTIZING BY CREW MEMBERS ON ACTIVE OR RESERVIST ROSTERS.]

## CLASS I MOBILE HOSPITAL

AUTHORIZED CONSTRUCTION

THE FOLLOWING SHIPS OF THE CONSOLATION CLASS MOBILE HOSPITAL HAVE BEEN AUTHORIZED AS PART OF THE FEDERATION STAR FLEET AS OF STARDATE 7712.00:

USS CONSOLATION - NCC 1424*	USS DELIVERANCE - NAR 1229	USS SAINT JOSEPH-NAR 1602
USS HOPE - NAR 1227	USS SAINT VINCENT-NAR 1230	USS SAINT MARY-NAR 1603
USS MERCY - NAR 1228	USS SAINT MARGARET-NAR 1231	

\* CLASS SHIP, \*\* LOST IN THE LINE OF DUTY, + UNDER CONSTRUCTION AS OF STARDATE 7712.00

---

### EDITOR'S ANNOTATIONS

THOUGH THE CONSOLATION SHOWN HERE IS BASED ON JOHN PAYNE'S KITBASH OF THE SHIP, THERE HAVE BEEN SEVERAL DESIGN SCHEMATICS BOTH WITH STRIKING SIMILARITIES OVER THE YEARS. THE BASIC CONCEPT, A 'STARLINER POD' PERMANENTLY ATTACHED TO A *CONSTITUTION*-STYLE HULL TO MAKE A LARGE MEDICAL SHIP, WAS RETAINED IN EACH DESIGN.

THE DESIGN GIVEN HERE KEEPS THAT OLD STANDBY, AND STICKS LARGELY WITH THE KITBASHED MODEL. THE MAIN DIFFERENCE IS THE USE OF THE REGULAR *CONSTITUTION* STYLE HULL INSTEAD OF THE COMBAT HULL FOUND ON THE *FEDERATION* CLASS. THE COMBAT-HARDENED HULL JUST DIDN'T MAKE A LOT OF SENSE FOR A HUMANITARIAN VESSEL.

ALSO, THE REGISTRY OF THE VESSEL WAS CHANGED TO A REGULAR NCC NUMBER, RATHER THAN THE UNIQUE 'NCC-H' DESIGNATION, BASED ON A SCHEME SEEN IN THE ANIMATED *STAR TREK* SERIES.



**CLASS I LARGE SURVEYOR**

HOPI CLASS STARSHIPS

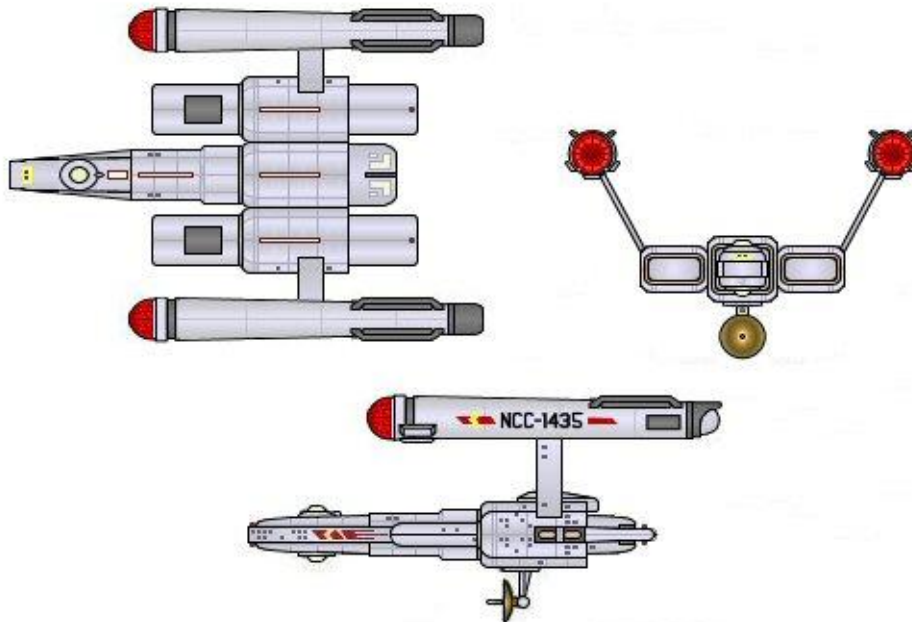

**CLASS NAME:** HOPI  
**CLASS DESIGNATION:** LARGE SURVEYOR, CLASS I  
**CLASS COMMISSION:** 2247

**COMPLEMENT (STD):**  
**OFFICERS:** 25  
**CREW:** 115

**DRIVE SYSTEM:**  
**IMPULSE:** FID-2 (75C)  
**WARP:** FWF-IS, TANDEM, (WF 5/7)

**ARMAMENT (STD):**  
**PHASERS:** 1 BANKS/2 EACH, TYPE FH-3

**SUPPLEMENTAL CRAFT (STD):**  
**CLASS F SHUTTLECRAFT:** 2  
**CLASS H TRAVEL POD:** 4

**DIMENSIONS:**  
**LENGTH:** 161M  
**BREADTH:** 117M  
**HEIGHT:** 80M  
**MASS (DEADWEIGHT):** 85MT

**GENERAL INFORMATION**

THE *HOPI*, IN MANY WAYS, IS AN ANACHRONISM, UTILIZING DESIGN PHILOSOPHIES CONSISTANT WITH THOSE FOUND IN OLDER VESSELS SUCH AS THE DY-500 CLASS. THOUGH SHE USES *CONSTITUTION* COMPONENTS, THE ASSEMBLY IS MUCH MORE MODULAR AND SPARTAN.

FOR THE FIRST TEN YEARS OF HER LIFESPAN, THE *HOPI* CLASS SERVED QUITE WELL IN CHARTING NEW TERRITORY AND EXPLORING NEW SECTORS. THE ENTIRE CLASS WAS USED TO HELP CHART SAFE NAVIGATION THROUGH THE GALAXY'S 'BERMUDA TRIANGE', THOUGH AT THE LOSS OF THE USS APIQUILLA.

THE *HOPI* CLASS, IN TRUTH, IS NEARING CLASS II STATUS, AS EVEN WITH THE *CONSTITUTION* COMPONENTS, HER DESIGN IS CLEARLY DATED. THE *CAPELLA* CLASS ALREADY FAR EXCEEDS THE *HOPI*'S CAPABILITIES, PARTICULARLY WITH THE USE OF SUPPLEMENTARY CRAFT.

AN ANYALYSIS OF THE CLASS'S SYSTEMS INDICATE THAT ANY PROJECTED POST 2271 REFIT WOULD BE BETTER SPENT ON OTHER SHIP DESIGNS, INCLUDING NEW SURVEYOR VESSELS. AS SUCH, THE *HOPI* CLASS WILL BE PHASED OUT AND EITHER RETIRED OR PLACED INTO RESERVE STATUS PENDING THE *ENTERPRISE* REFIT IN 2271.

## CLASS I LARGE SURVEYOR

AUTHORIZED CONSTRUCTION

THE FOLLOWING SHIPS OF THE HOPI CLASS SURVEYOR HAVE BEEN AUTHORIZED AS PART OF THE FEDERATION STAR FLEET AS OF STARDATE 7712.00:

USS HOPI - NCC 1435*	USS ALIQUIPPA - NCC 1438**	USS OYSTER BAY - NAR 1431
USS JICARILLA - NCC 1436	USS TAWAKONI - NCC 1439	USS SUISUN - NAR 1432
USS MOCTOBI - NCC 1437		

\* CLASS SHIP, \*\* LOST IN THE LINE OF DUTY, + UNDER CONSTRUCTION AS OF STARDATE 7712.00

---

### EDITOR'S ANNOTATIONS

THE *HOPI* FIRST APPEARED IN THE ANIMATED SERIES EPISODE 'THE TIME TRAP', BUT IN AN 'ALIEN' COLORING. IT WAS INTENDED TO BE AN ALIEN VESSEL OF SIMILAR TECHNOLOGY TO THE FEDERATION, BUT NOT NECESSARILY RELATED.

DESPITE THIS, MARK WILSON OF *FEDERATION FRONTIERS* ADOPTED THE SHIP, BASED ON HOW IT APPEARED, AND MADE IT INTO A FEDERATION STYLE STARSHIP. THE DESIGN HE GAVE SERVES AS THE BASIS FOR THE ONE PICTURED HERE.

**CLASS I TRANSPORT/TUG**

MONTOJO CLASS STARSHIPS

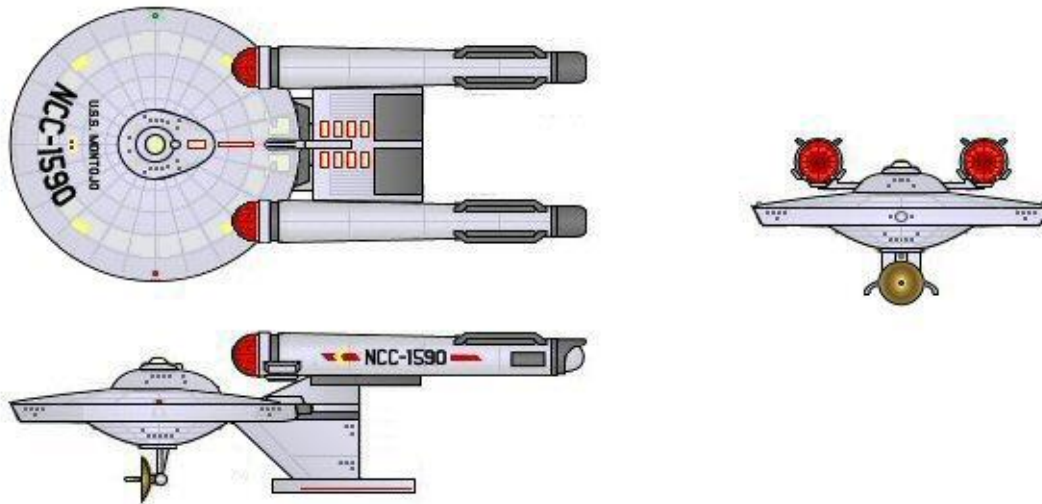

**CLASS NAME:** MONTOJOI  
**CLASS DESIGNATION:** TRANSPORT, CLASS I  
**CLASS COMMISSION:** 2264

**COMPLEMENT (STD):**  
**OFFICERS:** 22  
**CREW:** 45

**DRIVE SYSTEM:**  
**IMPULSE:** FID-2 (75C)  
**WARP:** FWF-1S, TANDEM, (WF 5/7)

**ARMAMENT (STD):**  
**PHASERS:** 1 BANKS/2 EACH, TYPE FH-3

**SUPPLEMENTAL CRAFT (STD):**  
**CLASS H TRAVEL POD:** 2

**DIMENSIONS:**  
**LENGTH:** 195M  
**BREADTH:** 95M  
**HEIGHT:** 68M  
**MASS (DEADWEIGHT):** 85MT

**GENERAL INFORMATION**

THE *MONTJOJO* REPRESENTS THE LAST OF THE *CONSTITUTION* ERA DESIGNS FOR A TRANSPORT. LIKE THE EARLIER, *PTOELMEY*, THE *MONTJOJO* USES THE STANDARD MODULAR TRANSPORT SYSTEM THAT'S PROVEN SO SUCCESSFUL. HOWEVER, IT DOES SO WITH A MORE 'ECONOMICAL' DESIGN, UTILIZING THE SMALLER FWF-1S WARP ENGINES AND THE SMALLER PRIMARY HULL.

THE ARRANGEMENT IS VERY SIMILAR TO THE SUCCESSFUL *HELLESPONT*, WHICH IS NO ACCIDENT. THE COMPACT, EFFECTIVE DESIGN HAS PROVEN QUITE POPULAR WITH THE ADMIRALTY, PARTICULAR WHEN USED FOR SHIPS WITH SUPPORT ROLES, SUCH AS THIS ONE.

THE ONLY TRUE DOWNSIDE TO THE DESIGN IS ITS TIMING. WITH ITS RELATIVELY LATE LAUNCH OF 2264, THE *MONTJOJO* IS COMING NEAR THE END OF THE *CONSTITUTION* ERA DESIGN, AND MAY BE OUTDATED SHORTLY AFTER HER LAUNCH. FOR A TRANSPORT, HOWEVER, THIS MAY NOT PROVE MUCH OF A PROBLEM.

THE LAST TWO SHIPS OF THIS TYPE REMAIN UNDER CONSTRUCTION, BUT UPGRADED DESIGNS, BASED ON BOTH THE *ARCHERFAR* PROJECT AND THE *ENTREPRISE* REFIT PROJECT IS PROJECTED FOR THE EARLY 2270'S.

## CLASS I TRANSPORT/TUG

AUTHORIZED CONSTRUCTION

THE FOLLOWING SHIPS OF THE MONTOJO CLASS TRANSPORT/TUG HAVE BEEN AUTHORIZED AS PART OF THE FEDERATION STAR FLEET AS OF STARDATE 7712.00:

USS MONTOJO - NCC 1590*	USS PASARON - NCC 1594	USS AQUINALDO - NCC 1598++
USS CAVERA - NCC 1591	USS LANGARA - NCC 1595	USS ANTHONIO - NCC 1599++
USS COLON - NCC 1592	USS TOPETE - NCC 1596	
USS OLIVA - NCC 1593	USS MORISCOS - NCC 1597	

\* CLASS SHIP, \*\* LOST IN THE LINE OF DUTY, + UNDER CONSTRUCTION AS OF STARDATE 7712.00

---

### EDITOR'S ANNOTATIONS

THE DESIGN FOR THE *MONTOJO* IS REALLY JUST A SLIGHT MODIFICATION OF THE *HELLESPONT* CLASS, USING A COMMON IDEA TO HAVE AN 'OUT OF THE WAY' MOUNTING OF THE WARP ENGINES, AND A SMALL PRIMARY HULL MORE SUITING TO A TRANSPORT THAN THE LARGE *PTOLEMY* CLASS OF SHIP.

THERE ARE MANY KITBASHED DESIGNS SIMILAR TO THIS, AND IT WOULD BE IMPOSSIBLE TO CREDIT THEM ALL. THE DESIGN GIVEN HERE IS AN ORIGINAL DRAWING BY THE AUTHOR, BUT IT WOULD BE UNFAIR TO TAKE CREDIT FOR THE CONCEPTS. AT BEST, IT CAN BE CONSIDERED A MERE VARIANT OF *STAR FLEET BATTLES'* WAR DESTROYER.

ALL SHIPS OF THE CLASS ARE NAMED AFTER HISTORICAL SPANISH ADMIRALS.

## TRANSPORT CONTAINERS

### OVERVIEW

THE CONCEPT OF MODULAR TRANSPORT CONTAINERS IS FAR FROM NEW. AS FAR BACK AS THE DY-100 CLASS, INTER-CHANGEABLE COMPONENTS HAVE BEEN USED TO EASE CARGO TRANSITION AS WELL AS ALLOW MISSION-SPECIFIC TRANSPORTATION WITHOUT REQUIRING AN ENTIRELY NEW SHIP.

THROUGH THE HISTORY OF THE EARTH FLEET, AND THEN THE STAR FLEET, HOWEVER, THE PROBLEM OF A 'STANDARD' CONTAINER SYSTEM, AS WELL AS A MILITARY-GRADE INTER-CHANGE SYSTEM, HAS KEPT MODULAR TRANSPORTATION SYSTEMS JUST OUT OF REACH.

IN 2040, A NEW DESIGN CONSIDERATION WAS ADDED FOR THE UPCOMING *CONSTITUTION* PROJECT, A NEW DESIGN FOR MODULAR TRANSPORTS. WITHIN A FEW YEARS, BOTH THE FIRST SHIP AND PODS WERE COMPLETED AT SPACEDOCK, AND THE NEW SYSTEM WAS BORN.

FOR TRANSPORT SHIPS FOLLOWING THE MODULAR TRANSPORT DESIGN, THE PRIMARY HULL AND DRIVE SYSTEM IS LINKED TO AN 'INTERLOCK' PORT, A STRONG LOCKING DEVICE WHICH CLAMPS THE TRANSPORT POD TO THE HOST SHIP BY WAY OF A JOINED PYLON. IN THIS WAY, A STARSHIP CAN MAKE USE OF A VARIETY OF CARGO CONTAINERS, FULFILLING

DIFFERENT NEEDS.

FOR TRANSPORT DUTIES, THE DOCKING SYSTEM HAS PROVEN REMARKABLY SUCCESSFUL. THE ABILITY TO SWITCH CARGO TYPES, AND EVEN 'FERRY' CARGO BETWEEN SHIPS WITHOUT LOADING AND UNLOADING HAS PROVEN TO BE A VALUABLE ASSET IN THE SPACELANES.

OF COURSE, IT DIDN'T TAKE LONG FOR SOME TO CONSIDER COMBAT APPLICATIONS FOR THE TRANSPORT POD SYSTEM, AND NEW DESIGNS FOR TROOP AND SHUTTLE TRANSPORTS, AS WELL AS 'BATTLE BARGE' SYSTEMS WERE QUICKLY DRAWN UP FOR TESTING.

THE RESULTS OF THE 'MILITARY APPLICATION' PODS HAVE BEEN MIXED. WHILE 'CHEAP TRANSPORT' MAY MAKE SENSE IN WARTIME, PARTICULARLY WHEN RESOURCES ARE SHORT, THEIR PERFORMANCE IN PEACETIME LAGS WELL BEHIND DEDICATED SHIPS OF THE SAME FUNCTION. ALSO, SINCE THE EXPECTED RISE IN TENSIONS WITH THE KLINGON EMPIRE DID NOT COME TO PASS, THE DESIGNS HAVE LARGELY BEEN SHELVED, WITH ONLY A FEW APPLICATIONS COMING TO FRUITION IN LIMITED NUMBERS.

### EDITOR'S ANNOTATIONS

THE 'TRANSPORT POD' SYSTEM WAS FIRST INTRODUCED IN FRANZ JOSEPH'S *STAR TREK TECHNICAL MANUAL*. IN IT, THE TRANSPORT/TUG CLASS, THE *PTOLEMY*, WAS SHOWN CAPABLE OF CARRYING A NUMBER OF TRANSPORT PODS. THE PODS COULD EITHER DOCK FRONT TO BACK TOGETHER, OR COULD DOCK TO A 'HOST' SHIP (LIKE THE *PTOLEMY*), FOR TRANSPORT.

THE *TECHNICAL MANUAL* INCLUDED THE 'STARLINER', 'DRY BULK', 'PRODUCTS', 'REEFER', AND 'LIQUID' PODS, LARGELY AS SEEN HERE. THE MAJOR CHANGES FROM THE ARE THE MARKINGS, WHICH REMOVE THE DEDICATED 'NCC' REGISTRY OF EACH POD AND ADOPTED A SUB-REGISTRY MORE SUITED TO THEIR OVERALL PURPOSE.

THE 'TROOP TRANSPORT', AND 'SHUTTLE-CARRIER' PODS ARE BASED ON NOTES FROM THE GAME *STAR FLEET BATTLES*, WHICH TOOK THE CONCEPT OF THE PODS AND RAN WILD WITH THEM. OF THE MULTITUDE OF COMBAT-CAPABLE PODS WITHIN THE GAME, THIS BOOK USES THE TWO MOST LIKELY TO ACTUALLY BE CONSTRUCTED.

THE 'DEUTERIUM FUEL' POD IS BASED LOOSELY ON MARK WILSON'S INTERPRETATION OF ONE OF THE SHIPS IN THE ANIMATED SERIES EPISODE "THE TIME TRAP". IT'S BEEN MODIFIED HEAVILY TO BE MORE IN KEEPING WITH THE OTHER POD DESIGNS.

THE 'COLONIST POD' IS AN ORIGINAL DESIGN BY THE AUTHOR, BUT BASED ON NUMEROUS DISCUSSIONS TAKING PLACE ON THE INTERNET. IT'S DESIGN IS EFFECTIVELY JUST THE STARLINER POD'S DESIGN, SLIGHTLY TWEAKED FOR ITS NEW MISSION PROFILE.

THE REPAIR FACILITY POD IS BASED ON IDEAS BROUGHT UP BY ERIC KRISTIANSEN. UNFORTUNATELY, HIS DESIGN COULD NOT BE FOUND AND A NEW ONE, BASED ON THE SPACEDOCKS SHOWN IN THE VARIOUS *STAR TREK* SERIES, WAS DRAWN UP IN ITS PLACE.

## TRANSPORT CONTAINER

PRODUCTS (FGP-001) TYPE

TC TYPE: PRODUCTS (FGP-001)

TC COMMISSION: 2249

COMPLEMENT (STD):

OFFICERS: 4

CREW: 20

DRIVE SYSTEM:

NONE

ARMAMENT (STD):

NONE

SUPPLEMENTAL CRAFT (STD):

NONE

DIMENSIONS:

LENGTH: 203M

BREADTH: 44M

HEIGHT: 44M

MASS (DW): 122MT

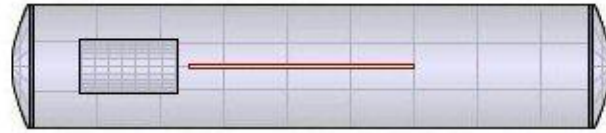

### GENERAL INFORMATION

THE 'PRODUCTS' POD IS DESIGNED FOR MASS TRANSIT OF 'FINISHED' GOODS AND MATERIALS. THE POD CAN CARRY UP TO 300,000 CUBIC METERS OF ASSORTED FREIGHT, IDEAL FOR RESUPPLYING STARBASES AND OUTPOSTS, AS WELL AS MAINTAINING SUPPLY LINES FOR STARFLEET ACTIVITIES.

THE FGP POD IS DESIGNED TO CARRY AN ASSORTMENT OF GOODS, SO IT MAINTAINS SEVERAL COMPARTMENTS FOR REFRIGERATION, LIQUID TRANSPORT, AND SO ON. DUE TO ITS GENERAL USE AND LARGE CAPACITY, THE FGP POD IS THE MOST COMMON TRY OF MATERIALS TRANSPORT POD IN USE.

## TRANSPORT CONTAINER

REFRIGERATION (FRF-001) TYPE

TC TYPE: REEFER (FRF-001)

TC COMMISSION: 2249

COMPLEMENT (STD):

OFFICERS: 4

CREW: 20

DRIVE SYSTEM:

NONE

ARMAMENT (STD):

NONE

SUPPLEMENTAL CRAFT (STD):

NONE

DIMENSIONS:

LENGTH: 203M

BREADTH: 44M

HEIGHT: 44M

MASS (DW): 100MT

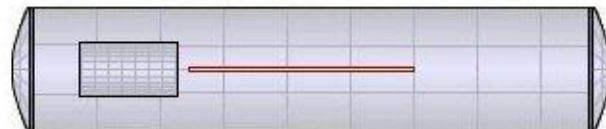

### GENERAL INFORMATION

THE 'REEFER', OR REFRIGERATION, POD IS USED TO TRANSPORT MATERIALS THAT ARE ENVIRONMENT SENSITIVE. 'REFRIGERATION' MAY BE A MISNOMER, SINCE THE PODS ARE CAPABLE OF TRANSPORTING AND DELIVERING GOODS IN HIGH-HEAT CONDITIONS AS WELL.

SINCE THE FGP POD HAS REFRIGERATION CAPACITIES OF ITS OWN, THE FRF PODS ARE RESERVED FOR LARGE-SCALE TRANSPORT OF ENVIRONMENTALLY SENSITIVE GOODS. CONSEQUENTLY, THERE ARE SIGNIFICANTLY FEWER 'REEFER' PODS THAN GENERAL PRODUCTS PODS IN THE SPACELANES.

## TRANSPORT CONTAINER

DRY BULK [FDB-001] TYPE

TC TYPE: DRY BULK (FDB-001)

TC COMMISSION: 2249

COMPLEMENT (STD):

OFFICERS: 4

CREW: 20

DRIVE SYSTEM:

NONE

ARMAMENT (STD):

NONE

SUPPLEMENTAL CRAFT (STD):

NONE

DIMENSIONS:

LENGTH: 203M

BREADTH: 44M

HEIGHT: 44M

MASS (DW): 122MT

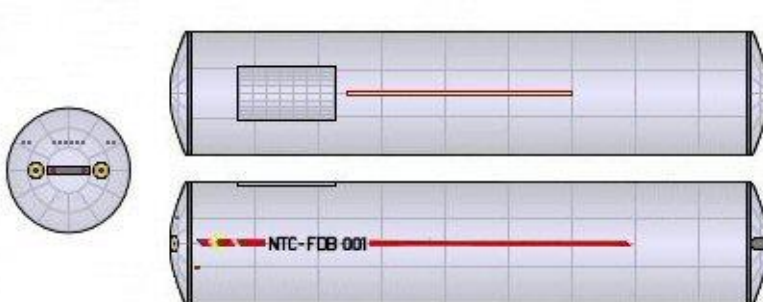

### GENERAL INFORMATION

THE 'DRY BULK' CONTAINER POD IS BASICALLY THE 'STRIPPED DOWN' TRANSPORT POD, WHERE LITTLE EQUIPMENT IS USED FOR SPECIAL HANDLING AND ENVIRONMENTAL CONCERNS.

FOR ITS DESIGN, THE 'DRY BULK' POD IS BASICALLY A STRIPPED-DOWN AND SOMEWHAT MORE ECONOMICAL POD WHEN COMPARED TO THE GENERAL PRODUCTS DESIGN. STARFLEET DOES KEEP A LARGE NUMBER OF THESE PODS ON HAND, AND ARE OFTEN REFERRED TO AS 'SNAIL MAIL' PODS, SINCE THEY OFTEN DELIVER STELLAR MAIL BETWEEN SHIPS, STARBASES, AND FEDERATION WORLDS.

## TRANSPORT CONTAINER

LIQUIDS [FGL-001] TYPE

TC TYPE: LIQUIDS (FGL-001)

TC COMMISSION: 2249

COMPLEMENT (STD):

OFFICERS: 4

CREW: 20

DRIVE SYSTEM:

NONE

ARMAMENT (STD):

NONE

SUPPLEMENTAL CRAFT (STD):

NONE

DIMENSIONS:

LENGTH: 203M

BREADTH: 44M

HEIGHT: 44M

MASS (DW): 88MT

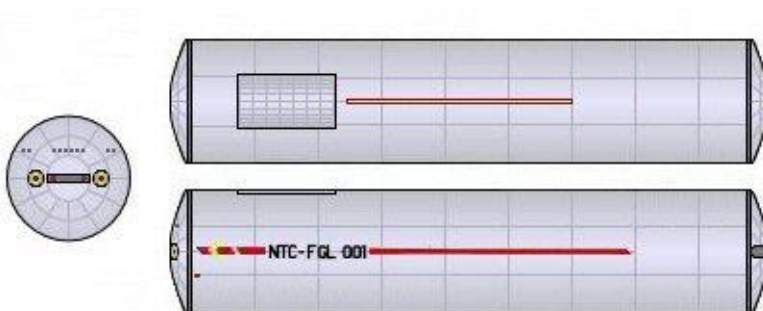

### GENERAL INFORMATION

THE 'LIQUIDS' POD IS DESIGNED WITH MULTIPLE PRESSURE AND TEMPERATURE-CONTROLLED COMPARTMENTS TO HANDLE THE TRANSPORTATION OF LIQUIDS OF VARIOUS TYPES, RANGING FROM COMMON WATER TO LOW-YIELD HYDROGEN PLASMA. THE POD'S SYSTEMS ARE DESIGNED TO KEEP EACH COMPARTMENTS' LIQUIDS AS STABLE AND SECURE AS POSSIBLE.

SINCE THE FGP POD HAS SIMILAR CAPACITIES OF ITS OWN, THE FGL PODS ARE RESERVED FOR LARGE-SCALE TRANSPORT OF LIQUIDS, SUCH AS INITIAL COLONY SUPPLIES, THERE ARE SIGNIFICANTLY FEWER 'LIQUIDS' PODS THAN GENERAL PRODUCTS PODS IN THE SPACELANES.

## TRANSPORT CONTAINER

STARLINER (SLR-001) TYPE

TC TYPE: STARLINER (SLR-001)

TC COMMISSION: 2252

COMPLEMENT (STD):

OFFICERS: 20

CREW: 175

DRIVE SYSTEM:

IMPULSE: FID-I (.55C)

ARMAMENT (STD):

NONE

SUPPLEMENTAL CRAFT (STD):

CLASS H TRAVEL POD: 2

CLASS F SHUTTLECRAFT: 4

DIMENSIONS:

LENGTH: 203M

BREADTH: 44M

HEIGHT: 44M

MASS (DW): 85MT



### GENERAL INFORMATION

THE 'STARLINER' POD IS NORMALLY IN USE BY CIVILIAN AGENCIES WITH AUXILIARY SHIPS RATHER THAN PART OF STARFLEET, THOUGH THERE HAVE BEEN A FEW EXCEPTIONS (MOSTLY FOR DIPLOMATIC PURPOSES, OR FOR THE YEARLY STARFLEET ACADEMY GRADUATION CRUISE.)

AN SLR-001 TYPE POD CAN ACCOMMODATE 300 TO 500 GUESTS IN HIGH LUXURY, WITH A WIDE VARIETY OF ENTERTAINMENT SERVICES, SPACIOUS ROOMS, AND FULLY STOCKED GALLEY. TO GET AN UNDERSTANDING OF THE LUXURY WITHIN THIS STARLINER, THE 'PRESIDENTIAL' TRAVEL TRANSPORT IS A UNIQUELY MODIFIED VERSION OF THE BASIC SLR-001 TYPE.

## TRANSPORT CONTAINER

COLONY TRANSPORT (CLN-001) TYPE

TC TYPE: COLONIST (CLN-001)

TC COMMISSION: 2252

COMPLEMENT (STD):

OFFICERS: 20

CREW: 175

DRIVE SYSTEM:

IMPULSE: FID-I (.55C)

ARMAMENT (STD):

NONE

SUPPLEMENTAL CRAFT (STD):

CLASS H TRAVEL POD: 2

CLASS F SHUTTLECRAFT: 4

DIMENSIONS:

LENGTH: 203M

BREADTH: 44M

HEIGHT: 44M

MASS (DW): 88MT



### GENERAL INFORMATION

THE 'WAGON TRAIN' POD IS DESIGNED TO TRANSPORT A LARGE NUMBER OF PEOPLE (AS MUCH AS TWO THOUSAND) AND ALL THEIR BELONGINGS, AS WELL AS BASIC MATERIALS TO BEGIN A COLONIZATION PROGRAM. AS SUCH, ROOMS ARE SMALL AND SPARTAN, WITH DESIGN EFFICIENCY DECIDEDLY GIVEN OVER TO 'MAKING THE MOST OF ANY ROOM THAT'S AVAILABLE'.

STARFLEET MAINTAINS VERY FEW OF THESE PODS ON THEIR OWN, PREFERRING TO ALLOW CIVILIANS TO COLONIZE SAFE WORLDS ON THEIR OWN. HOWEVER, COLONY TRANSPORT PROTECTION IS A VERY HIGH PRIORITY FOR STARFLEET, AND THESE PODS SOMETIMES SEEM TO BE MAGNETS FOR RAIDERS.



## TRANSPORT CONTAINER

MOBILE REPAIR (MRS-001) TYPE

TC TYPE: REPAIR (MRS-001)

TC COMMISSION: 2259

COMPLEMENT (STD):

OFFICERS: 12

CREW: 80

DRIVE SYSTEM:

IMPULSE: FID-I (.55C)

ARMAMENT (STD):

NONE

SUPPLEMENTAL CRAFT (STD):

CLASS H TRAVEL POD: 2

CLASS F SHUTTLECRAFT: 4

DIMENSIONS:

LENGTH: 203M

BREADTH: 53M

HEIGHT: 47M

MASS (DW): 55MT

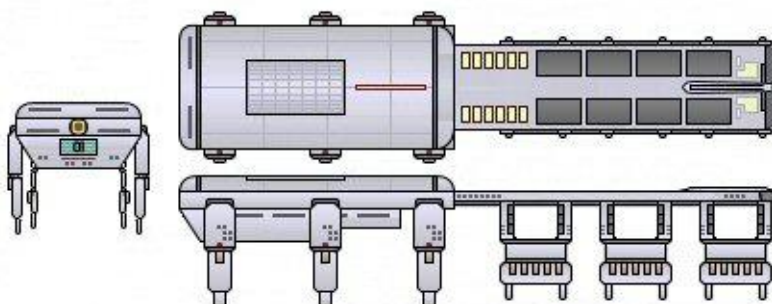

### GENERAL INFORMATION

A LIFESAVER FOR MORE THAN ONE STARSHIP CAPTAIN, THE 'MISSUS' POD ACTS AS A LIMITED-FACILITY DRYDOCK, CAPABLE OF HANDLING EMERGENCY REPAIRS AND MINOR SYSTEM REPAIRS IN THE FIELD. IT'S THE 'NEXT BEST THING' TO A REAL SPACEDOCK, AND CAN GET ALL BUT THE MOST SEVERELY DAMAGED STARSHIPS UP AND RUNNING IN SHORT ORDER.

THE MAIN AND REAR 'CLAMPS' ARE SHOWN AS RETRACTED, THOUGH THEY CAN EXTEND OUT TO ENCOMPASS THE PRIMARY HULL OF CURRENT CLASS I STARSHIPS. THOUGH TECHNICALLY POSSIBLE, IT IS AGAINST REGULATIONS FOR THE FACILITY TO BE IN USE WHILE ACTUALLY DOCKED TO ITS HOST SHIP.

## TRANSPORT CONTAINER

SHUTTLECARRIER (SCV-001) TYPE

TC TYPE: LIQUIDS (SVC-001)

TC COMMISSION: 2255

COMPLEMENT (STD):

OFFICERS: 40

CREW: 350

DRIVE SYSTEM:

IMPULSE: FID-I (.55C)

ARMAMENT (STD):

PHASERS: 3 BANK/2 EACH,

TYPE FH-3

SUPPLEMENTAL CRAFT (STD):

CLASS H TRAVEL POD: 4

CLASS F SHUTTLECRAFT: 8

CLASS HF SHUTTLECRAFT: 24

DIMENSIONS:

LENGTH: 203M

BREADTH: 44M

HEIGHT: 44M

MASS (DW): 88MT

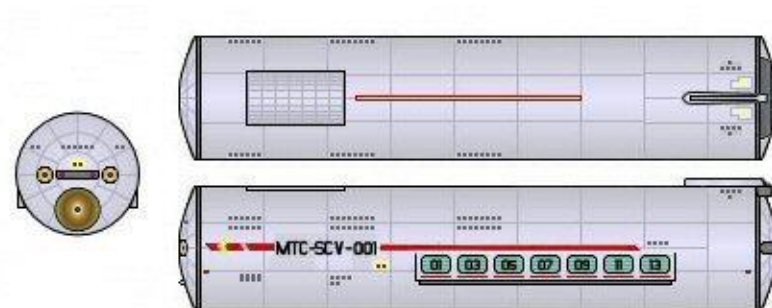

### GENERAL INFORMATION

A DESIGN FOR A WAR THAT NEVER CAME, THE SCV 'SHUTTLECARRIER' TRANSPORT WAS INTENDED AS A 'CHEAP FIGHTER EMBLACEMENT' SYSTEM. THE POD CARRIES A SIZABLE NUMBER OF HEAVY SHUTTLECRAFT, CAPABLE OF DEFENDING A COLONY OR OUTPOST IN POTENTIAL HAZARD ZONES.

THOUGH THE DESIGN IS RETAINED AS A 'WAR TIME EVENTUALITY', FEW OF THESE PODS WERE ACTUALLY CONSTRUCTED, AND THE FOUR IN SERVICE ARE USED PRIMARILY FOR TRAINING PURPOSES FOR STARFLEET AND STARFLEET MARINES. IT'S LIKELY THAT THIS POD TYPE WILL BE PHASED OUT ENTIRELY IN FAVOR OF DEDICATED LIGHT CARRIER SHIP DESIGNS IN THE FUTURE.

## TRANSPORT CONTAINER

DEUTERIUM/NEUTRONIC FUEL (FGP-001) TYPE

TC TYPE: PRODUCTS CHZD-001

TC COMMISSION: 2254

COMPLEMENT (STD):

OFFICERS: 4

CREW: 20

DRIVE SYSTEM:

NONE

ARMAMENT (STD):

NONE

SUPPLEMENTAL CRAFT (STD):

NONE

DIMENSIONS:

LENGTH: 87M

BREADTH: 44M

HEIGHT: 44M

MASS (DW): 46MT



### GENERAL INFORMATION

THE DEUTERIUM FUEL POD IS A UNIQUE DESIGN CREATED TO HOLD LARGE QUANTITIES OF BOTH HEAVY HYDROGEN (DEUTERIUM) AND ITS ANTI-MATTER EQUALIALENT (ANTI-DEUTERIUM). OBVIOUSLY, THE POD IS DESIGNED WITH SAFETY AS A PRIMARY CONSIDERATION! IT IS HEAVILY SHIELDED AND ARMORED, WITH THE BULK OF ITS INTERNAL EQUIPMENT DESIGNED TO MAINTAIN THE NEUTRONIC FUEL PLASMA IN A STEADY STATE FOR TRANSPORT.

FOR THE FEDERATION, MOST FUEL COLLECTION AND TRANSPORT IS DONE THROUGH CIVILIAN CHANNELS. AS SUCH, STARFLEET MAINTAINS ONLY A FEW OF THESE PODS FOR EMERGENCY AND STRATEGIC PURPOSES.

## TRANSPORT CONTAINER

MARINE TRANSPORT (TCV-001) TYPE

TC TYPE: MARINE TR (TCV-001)

TC COMMISSION: 2254

COMPLEMENT (STD):

OFFICERS: 40

CREW: 1600

DRIVE SYSTEM:

IMPULSE: FID-1 (.55C)

ARMAMENT (STD):

PHASERS: 3 BANK/2 EACH,

TYPE FH-3

SUPPLEMENTAL CRAFT (STD):

CLASS H TRAVEL POD: 2

CLASS F SHUTTLECRAFT: 4

CLASS HF SHUTTLECRAFT: 6

DIMENSIONS:

LENGTH: 203M

BREADTH: 44M

HEIGHT: 44M

MASS (DW): 88MT



### GENERAL INFORMATION

THE 'TROOP' POD IS A RARITY, BEING DESIGNED FOR WAR-TIME OPERATIONS AND PRESSED INTO SERVICE FOR A WAR WITH THE KLINGON EMPIRE THAT NEVER CAME. THE POD IS A 'BUDGET MILITARY TRANSPORT', CAPABLE OF MOVING A LARGE NUMBER OF TROOPS QUICKLY, BUT IN VERY SPARTAN CONDITIONS.

STARFLEET ORDERED A COUPLE OF DOZEN PODS OF THIS TYPE DURING ITS INITIAL APPROPRIATIONS AFTER THE AXANAR CONFLICT, BUT THEY HAVE SEEN LITTLE USING OUTSIDE OF TRAINING EXERCISES SINCE THAT TIME. THOUGH EFFECTIVE, IT'S LIKELY THAT STARFLEET MARINES WILL SIMPLY OPT FOR A NEW DEDICATED SHIP DESIGN AS THE TCV PODS ARE DECOMMISSIONED.

AUTHENTICATED STARDATE 7712.00

## CLASS F SHUTTLECRAFT

AUXILLARY CRAFT

TYPE: CLASS F SHUTTLE

COMMISSION: 2253

COMPLEMENT (STD):

CREW: 1

PASSENGERS: 6

DRIVE SYSTEM:

IMPULSE: FFI-2 (35C)

WARP: FFC-I, TANDEM, CWF 3/5)

ARMAMENT (STD):

NONE

DIMENSIONS:

LENGTH: 8M

BREADTH: 4.8M

HEIGHT: 2.7M

MASS (DW): 3.5T

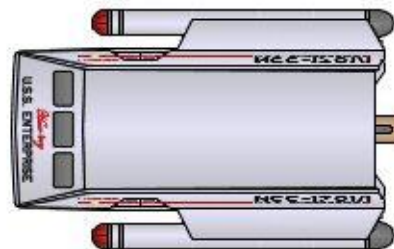

### GENERAL INFORMATION

THE CLASS F SHUTTLECRAFT WAS BROUGHT INTO SERVICE AS A 'MODERN' UPDATE TO THE AGING CLASS D-III SHUTTLES THAT SAW USE ABOARD THE *BATON ROUGE* ERA STARSHIPS. THOUGH THE NEW SHUTTLECRAFT RETAINS THE FAMOUS 'SHOE-BOX' EXTERIOR DESIGN, THE COMPONENTS AND INTERNAL WORKINGS OF THE NEW SHUTTLE COULDN'T BE MORE DIFFERENT.

THE MOST NOTABLE IMPROVEMENT TO THE SHUTTLE IS A LIMITED DURATION, IMPULSE-POWERED WARP DRIVE, ALLOWING THE SHUTTLE TO TRAVEL UP TO WARP 5 FOR A LIMITED DURATION. THIS MAKES THE SHUTTLE IDEAL FOR INTRA-STELLAR TRAVEL, DOING IN MINUTES OR HOURS WHERE THE OLDER, SUB-LIGHT VOYAGES IN SHUTTLECRAFT WOULD TAKE MONTHS.

CLASS F SHUTTLECRAFT ARE EQUIPPED WITH SHORT-RANGE SENSORS, EMERGENCY SUPPLIES, AND LOW-POWERED SHIELDS. THOUGH THEY CAN SURVIVE A MODERATE PHASER HIT, THEY'RE DECIDEDLY NOT DESIGNED TO SEE ACTION IN COMBAT.

OFFICIALLY, NO SHUTTLECRAFT RECEIVES A COMMISSIONING NAME. IT'S EXTREMELY COMMON, HOWEVER, FOR SHUTTLES PERMANENTLY ASSIGNED TO BASES OR LARGER SHIPS TO GAIN 'NICKNAMES' ASSIGNED BY THEIR COMMAND STAFF. REGULATIONS TECHNICALLY DEMAND THE SHUTTLES BE REFERENCED BY CALL-NUMBER, BUT THIS IS USUALLY IGNORED EVEN AT STARFLEET HEADQUARTERS.

### EDITOR'S ANNOTATIONS

THE SHUTTLECRAFT WAS CREATED BY MATT JEFFERIES FOR THE ORIGINAL *STAR TREK* TELEVISION SERIES. ODDLY ENOUGH, IT WAS MEANT FOR THE ORIGINAL SHOW TREATMENT, AND WAS NIXED WHEN THE 'TRANSPORTER' DECISION WAS FINALLY MADE. THE *ENTERPRISE* CREW WOULDN'T NEED A SHUTTLE AFTER ALL!

OF COURSE, THE SHUTTLE WOULD BE USED QUITE HEAVILY A LITTLE LATER ON IN THE SERIES, FINALLY MAKING SENSE OF THE GIANT CLAMHELL DOORS FOUND ON THE BACK OF THE *ENTERPRISE*, AS WELL AS ADDING AN 'AUXILLARY' VEHICLE THAT ALLOWED SOME SPACE-DRAMA WITHOUT THE USE OF EVERYTHING THAT THE BIG SHIP HAD TO OFFER.

THE 'WARP' DEBATE ON SHUTTLECRAFT STARTED LONG AGO, THOUGH THERE IS NO ON-SCREEN STATEMENT ANYWHERE THAT DECLARES THAT THE SHUTTLE IS INCAPABLE OF WARP SPEED. MORE THAN THAT, THERE ARE SEVERAL INSTANCES WHERE THE SHUTTLE *MUST* GO TO WARP SPEED, BUT IS CLEARLY SHOWN TO HAVE A LIMITED RANGE AND MAXIMUM SPEED WHEN COMPARED TO THE *ENTERPRISE*.

THE SIZE OF THE SHUTTLE IS LISTED HERE AT 8 METERS IN LENGTH, THOUGH THE OFFICIAL MEASUREMENT HAS 6.7 METERS IN LENGTH. THE OFFICIAL MEASURE SEEMS PARTICULARLY SMALL, HOWEVER, WHEN YOU LOOK AT THE HUMAN-SIZED DOOR PROMINENT IN THE SIDE OF THE CRAFT.

## CLASS H TRAVEL POD

AUXILLARY CRAFT

TYPE: CLASS H TRAVEL POD

COMMISSION: 2253

COMPLEMENT (STD):

CREW: 1

PASSENGERS: 3

DRIVE SYSTEM:

IMPULSE: FRCS-2 (.05C)

ARMAMENT (STD):

NONE

DIMENSIONS:

LENGTH: 3.8M

BREADTH: 2.3M

HEIGHT: 2.2M

MASS (DW): 1,1T



### GENERAL INFORMATION

BY AND LARGE, THE TRAVEL POD IS A MAINTENANCE CRAFT, USED FOR TRANSIT BETWEEN NEARBY SHIPS AND BASES AND VERY SHORT-TERM VOYAGES. THE PODS ARE LITTLE MORE THAN GLORIFIED FERRIES FOR PERSONNEL, AND ILL-SUITED FOR MUCH ELSE. AS MANY OF STARFLEET PERSONNEL SAY, THE TRAVEL PODS ARE MERELY 'GLORIFIED SPACE TAXIS'.

TRAVEL PODS DO SEE USE AT STARBASES AND SPACEDOCKS, HOWEVER, PARTICULARLY WHEN TRANSFERRING KEY PERSONNEL DURING A VESSEL'S REFIT PERIOD. ALSO, THEY ARE DESIGNATED AS EMERGENCY AUXILLARY CRAFT, SO NEARLY ALL FEDERATION VESSELS WILL BE ASSIGNED A COUPLE OF THESE PODS IN CASE OF EMERGENCIES.

UNLIKE LARGER SHUTTLECRAFT, THE TRAVEL POD ISN'T PERMANENTLY ASSIGNED TO ANY SHIP OR STATION, AND DOESN'T USUALLY GAIN A SPECIALIZED REGISTRY.

### EDITOR'S ANNOTATIONS

THE TRAVEL POD WAS ORIGINALLY DESIGNED BY MATTHEW PROBERT FOR *STAR TREK: THE MOTION PICTURE*, AND SERVED AS A FERRY BETWEEN STARBASE AND THE NEWLY REFIT *ENTERPRISE*. SINCE THEN, THE TRAVEL POD FEATURED IN THE REMAINING 'ORIGINAL CAST' FILMS.

THE POD HERE IS BASED ON THAT DESIGN, BUT CROSSED WITH THE CLASS F SHUTTLECRAFT TO GIVE IT A LOOK MORE IN KEEPING WITH THE ORIGINAL *STAR TREK* SERIES.

THERE'S REALLY ONLY ONE PROBLEM WITH THE TRAVEL POD AS DESCRIBED IN MOST OFFICIAL WORKS, AND THAT'S THAT THE MODEL OF THE ORIGINAL *ENTERPRISE* DIDN'T HAVE ANY OBVIOUS ACCESS PORTS LIKE THE REFIT VERSION. THE TRAVEL PODS, WITH THE DISTINCTIVE 'ROUND HATCH' AT THE REAR, WOULDN'T HAVE ANYWHERE OBVIOUS TO DOCK!

AUTHENTICATED STARDATE 7712.00

## CLASS HF SHUTTLECRAFT

AUXILLARY CRAFT

TYPE: CLASS HF SHUTTLE

COMMISSION: 2259

COMPLEMENT (STD):

CREW: 2

PASSENGERS: 8

DRIVE SYSTEM:

IMPULSE: FFI-2 (35C)

WARP: FFC-I, TANDEM, CWF 3/5)

ARMAMENT (STD):

PHASERS:

1 BANKS/2 EACH, TYPE FHS-3

DIMENSIONS:

LENGTH: 11.1M

BREADTH: 5.2M

HEIGHT: 2.7M

MASS (CDW): 6.8T

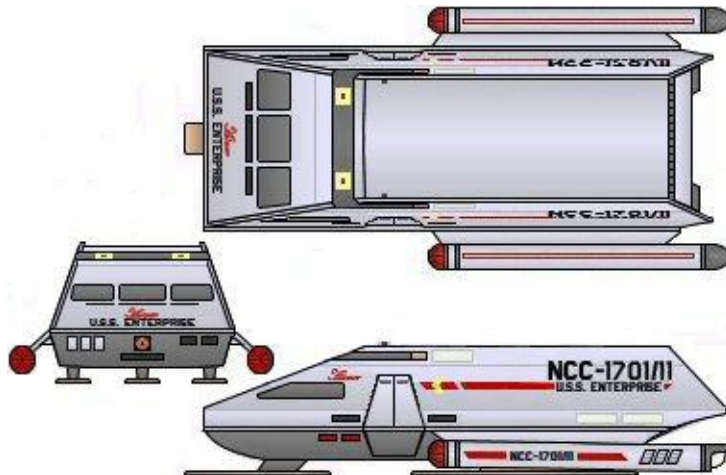

### GENERAL INFORMATION

THE HF 'HEAVY' SHUTTLE WAS CREATED IN RESPONSE TO THE PERILS OF DEEP SPACE EXPLORATION AND THE RELATIVE WEAKNESSES OF REGULAR CLASS F SHUTTLES IN MORE HAZARDOUS SITUATIONS. THE HF SHUTTLE WAS DESIGNED TO BE BIGGER, HEAVIER, AND EVEN ALSO ARMED.

THE HF SHUTTLE CERTAINLY ACCOMPLISHES ITS OBJECTIVES, BUT DOES SO AT NEARLY DOUBLE THE MASS OF A REGULAR SHUTTLE, MAKING THE CRAFT A RARITY EVEN AMONG THOSE SHIPS FOR WHICH IT WAS DESIGNED. CURRENT SHIP DESIGNS OFTEN REQUIRE SACRIFICING TWO REGULAR CLASS F SHUTTLES TO HOUSE ONE OF THE HF VARIETY, A COMPROMISE THAT SHIP COMMANDERS HAVE TO CAREFULLY CONSIDER.

THE ADDITION OF A PAIR OF LIGHT PHASER BANKS AND INCREASED SHIELDS, HOWEVER, IS AN ATTRACTIVE ASSET IN A SHUTTLE. WHILE NOT TRULY SUITED FOR STARSHIP COMBAT, AN HF SHUTTLE IS CAPABLE OF SOME SELF DEFENSE, ENOUGH TO DEAL WITH SMALLER RAIDING VESSELS OR BUY TIME FOR HER HOST SHIP TO ARRIVE.

OUTSIDE OF STARSHIP AUXILLARY USE, HOWEVER, THE HF SHUTTLE HAS SEEN SOME POPULARITY AS A SHORT-RANGE COURIER, PARTICULARLY IN TRAVEL BETWEEN CORE FEDERATION WORLDS. AS A RESULT, SOME CONSIDERATION IS BEING GIVEN TO MAKING A VARIANT OF THE HF INTO A DEDICATED RUNABOUT VESSEL ON ITS OWN.

### EDITOR'S ANNOTATIONS

THE HEAVY SHUTTLE ORIGINALLY DEBUTED IN *STAR TREK*, THE ANIMATED SERIES, AND WAS BASICALLY JUST A BIGGER, MORE POWERFUL SHUTTLECRAFT. IT MADE SENSE THAT THE *ENTERPRISE* WOULD GET BETTER SHUTTLES, THOUGH, CONSIDERING HOW BACK OF LUCK THEY HAD WITH THEIR OLDER ONES.

THE DESIGN MODEL FOR THE ANIMATED SERIES WAS SERIOUSLY FLAWED, HOWEVER. NONE OF THE VIEWS MATCHED UP, THE SCALE WAS COMPLETELY WRONG WHEN COMPARED TO THE REGULAR SHUTTLECRAFT, AND SEVERAL FEATURES (SUCH AS THE ACTUAL DOOR) ON THE SHUTTLE WOULD BE IMPOSSIBLE IF THE SHIP WERE A REAL, THREE-DIMENSIONAL MODEL. GRANTED, THIS *IS* FILMATION WE'RE TALKING ABOUT.

THE DESIGN HERE IS A COMPLETE REDRAW OF THE SHIP, USING THE BASIC IDEA OF THE PROFILE AND MESHING IT A LOT MORE WITH THE ORIGINAL SHUTTLECRAFT SEEN IN THE ORIGINAL SERIES. THE RESULT IS NOT ONLY A HEAVY SHUTTLECRAFT, BUT SOMETHING THAT COULD BE A FORERUNNER TO THE RUNABOUTS THAT COME LATER IN THE TREK UNIVERSE.

## CLASS E SHUTTLEPOD

AUXILLARY CRAFT

TYPE: CLASS E SHUTTLE

COMMISSION: 2255

COMPLEMENT (STD):

CREW: 1

PASSENGERS: 1

DRIVE SYSTEM:

IMPULSE: FFI-2 (35C)

WARP: FFC-I, TANDEM, CWF 3/5)

ARMAMENT (STD):

NONE

DIMENSIONS:

LENGTH: 4.8M

BREADTH: 3.5M

HEIGHT: 2.7M

MASS (DW): 1,2T

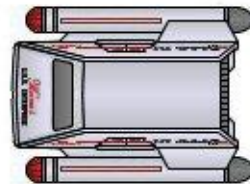

### GENERAL INFORMATION

THE SHUTTLEPOD WAS INTRODUCED IN 2255 AS A LIGHTER, MORE ECONOMICAL SHUTTLECRAFT, DESIGNED FOR SHORT DURATION, WARP CAPABLE TRIPS FOR ONE OR TWO PASSENGERS.

DESPITE IT'S ECONOMIC DESIGN, AND ABILITY TO TRAVEL AT LOW TO MEDIUM WARP FOR SEVERAL HOURS, THE LIGHT SHUTTLEPOD HASN'T BEEN TOO POPULAR ABOARD STARSHIPS. IT'S NOT THAT THE CLASS E SHUTTLEPOD IS A BAD IDEA *PER SE*, BUT THAT THE SMALLER, MORE FRAGILE POD IS SEEN AS BEING TOO 'LIGHTWEIGHT' FOR USE ON SHIPS PRONE FOR MORE HAZARDOUS DUTY.

SELDOM DOES A SHIP COMMANDER FEEL COMFORTABLE WITH THE LIGHT SHUTTLEPOD WHEN THE SAME JOBS CAN BE HANDLED WITH A REGULAR CLASS F SHUTTLE, AND WITH MUCH MORE ROOM FOR CONTINGENCIES.

THAT DRAWBACK ASIDE, HOWEVER, THE SHUTTLEPOD DOES SEE QUITE A BIT OF USE WITHIN STARBASES AND WITHIN THE INNER WORLDS OF THE FEDERATION, WHERE HAZARDOUS SITUATIONS ARE NOT AS LIKELY AND 'QUICK TRIPS' ARE MORE FREQUENT FOR KEY PERSONNEL FIGURES.

### EDITOR'S ANNOTATIONS

THE SHUTTLEPOD SHOWN HERE IS BASED HEAVILY ON THE *STAR TREK: NEXT GENERATION* SHUTTLEPOD DESIGNED BY RICK STERNBACH. OF COURSE, IT'S BEEN LARGELY GIVEN AN 'ORIGINAL SERIES' REDRESS, MAKING IT THE 'SPORTS CAR' VERSION OF THE CLASS F 'SEDAN'.

THE PRODUCTION PURPOSE OF THE POD WAS TO HAVE A SMALLER, CHEAPER ALTERNATIVE TO THE REGULAR SHUTTLECRAFT, PARTICULARLY FOR 'LIVE ACTION' SHOTS WHERE THE LARGER SHUTTLE PROP PROVED ENTIRELY UNCONVINCING. TO KEEP THINGS CONSISTANT, THE POD DIDN'T *REPLACE* THE ORIGINAL SHUTTLECRAFT, AND INSTEAD SERVED AS A SMALLER, SHORTER-TRIP ALTERNATIVE IN THE SCRIPTS.

THE BASIC CONCEPTS USED IN *STAR TREK: THE NEXT GENERATION* ARE USED HERE, THOUGH RETROGRADED IN KEEPING WITH THE ORIGINAL SERIES TECHNOLOGY AND DESIGNS.

AUTHENTICATED STARDATE 7712.00

## CLASS AF SHUTTLECRAFT

AUXILLARY CRAFT

TYPE: CLASS HF SHUTTLE

COMMISSION: 2263

COMPLEMENT (STD):

CREW: 2

PASSENGERS: 8

DRIVE SYSTEM:

IMPULSE: FFI-2 (35C)

WARP: FFC-1, TANDEM, CWF 3/5)

CHEM: FPC-2. (150KPH)

ARMAMENT (STD):

PHASERS:

1 BANKS/2 EACH, TYPE FHS-3

DIMENSIONS:

LENGTH: 7.7M

BREADTH: 4.5M

HEIGHT: 1.6M

MASS (DW): 5,2T

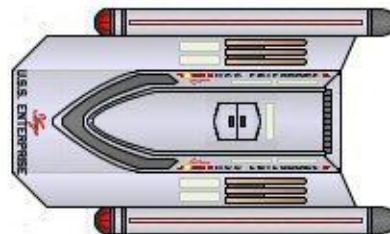

### GENERAL INFORMATION

THE AF 'AQUA' SHUTTLE WAS DESIGNED TO SERVE A SPECIFIC PURPOSE, THE EXPLORATION OF WORLDS PRIMARILY COVERED IN WATER (OR OTHER LIQUIDS). THE SHUTTLE WOULD NEED TO BE HIGHLY PRESSURIZED, AND HAVE SENSITIVE EQUIPMENT FOR EXPLORATION OF THE OCEAN DEPTHS.

THE AF SHUTTLE WOULD BE A MARKED DEPARTURE FROM OTHER SHUTTLE DESIGNS, AS IT'S 'DUAL ROLE' OF BEING BOTH SUBMARINE AND SPACE SHUTTLE WOULD PRESENT SOME UNIQUE CHALLENGES.

THE CANOPY OF THE SHUTTLE IS DEFINITELY NON-STANDARD, USING A 'HATCH' SYSTEM MORE COMMONLY FOUND ON SUBMERSIBLES. A THIRD PROPULSION SYSTEM, BEYOND THE WARP AND IMPULSE DESIGN, ALLOWS FOR 'UNDERWATER' TRAVEL SPEEDS, A NECESSITY WHEN CONSIDERING THAT EVEN SLOW IMPULSE TRAVEL WOULD RIP APART AND IONIZE AN OCEAN! (AND LIKELY DESTROY THE SHUTTLE DURING THE ATTEMPT).

THE AF SHUTTLE IS AN EXPENSIVE PIECE OF EQUIPMENT, PRIMARILY USED FOR EXPLORATION OR TRAVEL ON THOSE WORLDS WITH LARGE UNDERWATER POPULATION CENTERS (LIKE THE CARRIBEAN FLOOR ON EARTH). WITH ITS HIGH PRICE AND RATHER SPECIFIC USE, HOWEVER, THE AF SHUTTLE IS A RARITY ON STARSHIPS. SHIPS WITH EXPLORATION MISSIONS TEND TO HAVE ONLY ONE OR TWO ASSIGNED TO THEM, AND ARE STILL USED QUITE SPARINGLY.

### EDITOR'S ANNOTATIONS

THE AQUASHUTTLE ORIGINALLY DEBUTED IN *STAR TREK*, THE ANIMATED SERIES, AND, LIKE THE HEAVY SHUTTLE, SUFFERED FROM A NOT-WHOLLY-THOUGHT-OUT DESIGN. THE SHUTTLE'S VIEWS, FORTUNATELY, WERE CONSISTANT, BUT THE DESIGN WAS LACKING ENGINES, AN ENTRY HATCH, ETC. AGAIN, IT WAS A 'SKIMPED' DESIGN BY FILMATION.

OTHER THAN THE DETAILS, THE ONLY REAL PROBLEM WITH THE AQUASHUTTLE AS SEEN WAS ITS VERY LARGE SIZE, BEING A SMALL-CLASS STARSHIP ON ITS OWN RIGHT, RATHER THAN A SHUTTLE. AS WITH OTHER THINGS IN THE ANIMATED *STAR TREK* SERIES, SCALE WOULD BE A MAJOR PROBLEM. WITHIN THE HANGAR DECK OF THE ENTERPRISE, THE AQUASHUTTLE WAS NO LARGER THAN A TYPICAL SHUTTLE. OUTSIDE, HOWEVER, IT WAS SIMPLY HUGE, SIZING IT AT NEARLY 40M IN LENGTH!

THE PICTURE HERE KEEPS THE BASIC LINES OF THE CRAFT, THOUGH BULKS UP THE 'PASSENGER' AREA OF THE SHUTTLE, MAKING IT MORE IN LINE WITH THE OTHER SHUTTLE-CRAFT, AS WELL AS ADDING THE NEEDED DETAILS MENTIONED EARLIER.



## CLASS L COURIER SHUTTLE

AUXILLARY CRAFT

TYPE: CLASS L SHUTTLE

COMMISSION: 2263

COMPLEMENT (STD):

CREW: 2

PASSENGERS: 8

DRIVE SYSTEM:

IMPULSE: FFI-2 (35C)

WARP: FFC-I, TANDEM, CWF 3/5

ARMAMENT (STD):

NONE

DIMENSIONS:

LENGTH: 11M

BREADTH: 5.8M

HEIGHT: 2.9M

MASS (DW): 6.5T

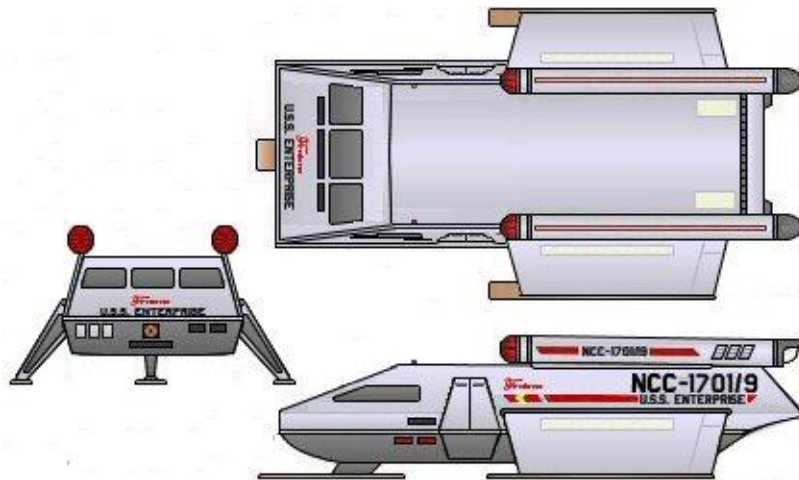

### GENERAL INFORMATION

THE CLASS L SHUTTLE, OR 'COURIER SHUTTLE' WAS DEVELOPED AS A LONG RANGE, MEDIUM WARP SHUTTLE. ITS PURPOSE WAS PRIMARILY TO SHUTTLE SMALL CARGOS AND PERSONEEL BETWEEN STARBASES, FEDERATION WORLDS, AND SHIPS IN THE FIELD.

THE ONLY DRAWBACK TO THE SHUTTLE IS ITS RELATIVE SIZE, WHICH TAKES UP 'PARKING SPACE' LIKE A HEAVY SHUTTLE AND COMES AT THE COST OF TWO REGULAR CLASS F SHUTTLECRAFT. STARSHIP COMMANDERS MAY KEEP ONE OF THESE COURIERS AVAILABLE ANYWAY, BUT TEND TO PREFER THE CLASS F SHUTTLES FOR AN AUXILLARY ROLE.

AS A DEDICATED COURIER VESSEL, HOWEVER, THE CLASS L SHUTTLE HAS ENJOYED FAR GREATER SUCCESS. THE LAREGR DESIGN FOCUSES MUCH MORE ON LONG DURATION TRIPS AND RELATIVE COMFORT FOR ITS PASSENGERS. THE MOST NOTABLE ADDITIONS, AT LEAST FOR ITS PASSENGERS, ARE THE INCLUSION OF A LAVAROTORY AND SLEEPING BED IN THE REAR OF THE 'LIVING' AREA OF THE SHIP.

THE COURIER DESIGN HAS PROVEN SO POPULAR AS A CRAFT IN ITS OWN RIGHT, THAT CIVILIAN AGENCIES HAVE BEGUN PETITIONING FOR A DECLASSIFIED VERSION FOR PRODUCTION. MORE THAN LIKELY, A NEW DESIGN USING DECLASSIFIED COMPONENTS WILL BE ACCEPTED FOR FUTURE USE IN THE NEAR FUTURE.

### EDITOR'S ANNOTATIONS

THE LONG RANGE SHUTTLE FIRST APPEARED IN THE ANIMATED SERIES EPISODE 'THE SLAVER WEAPON', THOUGH, AS USUAL, IT HAD A FEW PROBLEMS, BOTH WITH SCALE (IT WAS, AGAIN, TOO HUGE TO BE A SHUTTLE) AND WITH LAYOUT (NO DOOR, NO IMPULSE DRIVE SYSTEM, ETC).

IN ADDITION, THE OTHER TIME THE SHUTTLE WAS SHOWN WAS A VERY BADLY DRAWN SMALL SHOT WITHIN THE *ENTERPRISE*'S HANGAR BAY. THE SHUTTLE IS SHOWN TO BE SMALLER THAN A REGULAR CLASS F SHUTTLE, AND IS MISSING ITS WINGS. AGAIN, FILMATION'S USUAL STANDARDS OF QUALITY APPLY.

THE VERSION HERE TAKES THAT DESIGN AND CLEANS IT UP A LITTLE, MAKING IT SYNC MORE WITH THE CLASS F SHUTTLE-CRAFT SEEN IN THE ORIGINAL SERIES. IT ALSO ADDS THE DOOR, AND SCALES THE SHUTTLE MORE PROPERLY.



## CONSTITUTION CLASS PROJECT TIMELINE

SKELETAL SUMMARY—ADDENDUM

### 2247

*USS HOPI* LAUNCHED WITH NEW FWF-1S ENGINES. OLDER DESIGN PROVES MODERATELY EFFECTIVE, BUT THE *HOPI* IS ONE OF THE LAST SHIPS OF ITS DESIGN LINEAGE WITHIN STAR FLEET.

*SHERMAN* CLASS LAUNCHED USING EXISTING DESIGNS UP-GRADED TO *CONSTITUTION* SPECIFICATIONS. NEW DUOTRONIC AUTOMATION SYSTEM MAKES THE CLASS MUCH MORE EFFECTIVE THAN DESIGNERS ANTICIPATED.

### 2249

*MANHATTAN* CLASS LAUNCHED, DESIGNED TO BRING THE BENEFITS OF THE *SHERMAN* AND PLANNED *PTOLEMY* CLASSES TOGETHER. FIRST SHIP CLASS FIELDIED TO MAKE USE OF THE 'STANDARD POD' DESIGNS.

DRY BULK, REEFER, PRODUCTS, AND LIQUID TRANSPORT PODS ARE APPROVED FOR USE WITHIN STARFLEET.

### 2251

*USS APIQUILLA* LOST WHILE INVESTIGATING TEMPORAL ANOMALY NEAR THE NEUTRAL ZONE.

### 2252

STARLINER AND COLONIST TRANSPORT PODS APPROVED FOR STARFLEET USE. STARLINER PODS, IN PARTICULAR, PROVE IMMEDIATELY POPULAR FOR CIVILIAN USE.

*PTOLEMY* CLASS LAUNCHED AS A 'HEAVY TRANSPORT' STARSHIP.

POD CONNECTION SYSTEM DECLASSIFIED AND APPROVED FOR CIVILIAN USE WITHIN THE FEDERATION.

### 2253

CLASS F SHUTTLECRAFT INTRODUCED INTO SERVICE, REPLACING THE NOW HEAVILY-DATED CLASS D-III TYPE OF SHUTTLE. THE NEW SHUTTLES PROVE IMMENSELY POPULAR FOR SHORT-VOYAGE CRAFT.

CLASS H TRAVEL PODS ARE PUT INTO SERVICE, PRIMARILY SERVING AS 'QUICK TRANSPORT' AND 'EMERGENCY' AUXILIARY CRAFT.

CLASS E SHUTTLEPOD APPROVED FOR GENERAL STARFLEET USE. THOUGH MOST LARGE SHIPS ARE SUPPOSED TO CARRY A FEW OF THESE SHUTTLECRAFT, MANY COMMANDERS ESCHEW THEM COMPLETELY IN FAVOR OF THE LARGER, MORE DURABLE CLASS F.

### 2254

TROOP TRANSPORT POD APPROPRIATED IN ANTICIPATION OF MILITARY OPERATIONS AGAINST THE KLINGON EMPIRE. THOUGH THE PODS PROVE EFFECTIVE, TENSIONS DO NOT ES-

CALATE TO THE POINT WHERE THE PODS ARE PRESSED INTO HEAVY SERVICE.

DEUTERIUM POD APPROVED AFTER EXTENSIVE TESTING. THOUGH DESIGNED TO 'LINK TOGETHER' LIKE OTHER FEDERATION PODS, IT IS RULED IN VIOLATION OF REGULATIONS TO LINK DEUTERIUM PODS TOGETHER.

### 2255

SHUTTLECARRIER POD APPROVED FOR USE BY STARFLEET. INITIAL APPROPRIATIONS ARE VERY LOW, AND THE POD TYPE ITSELF IS 'DISCONTINUED' ONLY A YEAR LATER IN FAVOR OF DEDICATED LIGHT SHUTTLECARRIER DESIGNS.

### 2258

*DERF* CLASS TENDER LAUNCHED.

### 2259

THE 'MRS' MOBILE REPAIR SYSTEM IS LAUNCHED.

THE CLASS HF 'HEAVY' SHUTTLECRAFT IS BROUGHT INTO SERVICE. FOR MORE HAZARDOUS DUTIES THAN THE REGULAR CLASS F CAN GENERALLY MANAGE.

### 2262

PLANS FOR UPGRADED INTERLOCK SYSTEM ARE COMMISSIONED, BASED ON LESSONS LEARNED FROM THE NOW OLDER, *PTOLEMY* DESIGN. DUE TO THE OLDER DESIGN'S WIDE USE, AND LACK OF PRESSING NEED, THE NEW SYSTEM IS PUSHED BACK PENDING RESULTS OF 'NEXT GENERATION' TECHNOLOGY.

CLASS L COURIER SHUTTLE PUT INTO SERVICE. AS WITH THE HEAVY SHUTTLE, THE COURIER SEES LITTLE ACCEPTANCE AS A REGULAR AUXILIARY CRAFT, BUT DOES ENJOY GREATER ACCEPTANCE FOR STARBASES AND FEDERATION WORLDS AS UNATTACHED GENERAL COURIER SHIPS.

### 2263

*CONSOLATION* HOSPITAL SHIP HURREDLY COMMISSIONED TO DEAL WITH RISIGN NUMBER OF MEDICAL EMERGENCIES ON COLONY WORLDS. SEVERAL SHIPS OF THE TYPE ARE QUICKLY COMMISSIONED AS RESERVIST SHIPS.

TYPE AF SHUTTLE APPROVED FOR USE ON STARFLEET SHIPS. THE RELATIVE EXPENSE AND RARITY OF NECESSITY, HOWEVER, KEEPS THE 'AQUASHUTTLE' UNDER EXTREMELY LIMITED USE.

### 2264

*USS MONTQJD* CLASS LAUNCHED, USING THE SUCCESSFUL DESIGN ELEMENTS OF THE *HELLESPONT* CLASS. THE NEW TUG PROVES RELIABLE AND MORE ECONOMICAL THAN THE HEAVIER *PTOLEMY* CLASS, BUT ITS RELIANCE ON *CONSTITUTION* CLASS COMPONENTS MAY, BY 2264, LIMIT ITS OVERALL LIFE SPAN.

## SHUTTLECRAFT COMPARISON GUIDE



CLASS F SHUTTLECRAFT  
CLASS COMMISSION: 2253  
LENGTH: 8M



CLASS H TRAVEL POD  
CLASS COMMISSION: 2253  
LENGTH: 3.8M



CLASS HF SHUTTLECRAFT  
CLASS COMMISSION: 2259  
LENGTH: 11.1M



CLASS E SHUTTLECRAFT  
CLASS COMMISSION: 2255  
LENGTH: 4.8M



CLASS AF SHUTTLECRAFT  
CLASS COMMISSION: 2263  
LENGTH: 7.7M



CLASS L SHUTTLECRAFT  
CLASS COMMISSION: 2263  
LENGTH: 11M

## STARSHIP COMPARISON GUIDE - VOLUME TWO

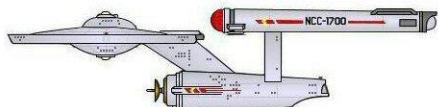

**CONSTITUTION CLASS HEAVY CRUISER**  
**CLASS COMMISSION: 2245**  
**LENGTH: 290M**

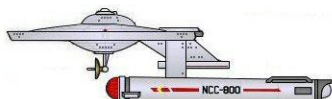

**PTOLEMY CLASS TRANSPORT/TUG**  
**CLASS COMMISSION: 2252**  
**LENGTH: 221M**

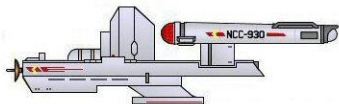

**MANHATTAN CLASS TRANSPORT/TUG**  
**CLASS COMMISSION: 2249**  
**LENGTH: 225M**

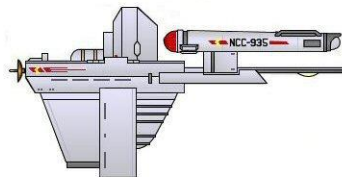

**SHERMAN CLASS FREIGHTER**  
**CLASS COMMISSION: 2247**  
**LENGTH: 227M**

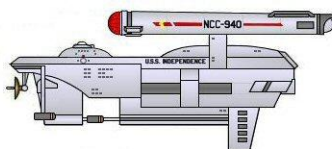

**INDEPENDENCE CLASS ARMED FRIEGHTER**  
**CLASS COMMISSION: 2252**  
**LENGTH: 221M**

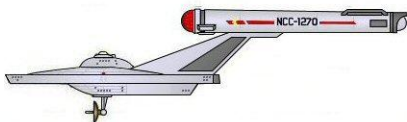

**DERF CLASS TENDER**  
**CLASS COMMISSION: 2258**  
**LENGTH: 273M**

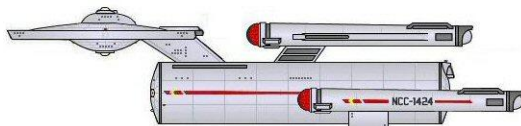

**CONSOLATION CLASS MOBILE HOSPITAL**  
**CLASS COMMISSION: 2263**  
**LENGTH: 350M**



**HOPI CLASS SURVEYOR**  
**CLASS COMMISSION: 2247**  
**LENGTH: 161M**



**MONTOJO CLASS TRANSPORT/TUG**  
**CLASS COMMISSION: 2264**  
**LENGTH: 195M**

